

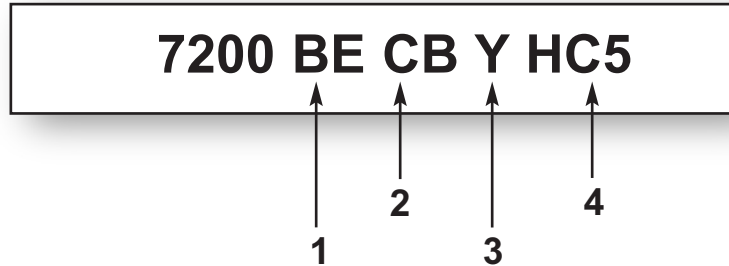

Angular Contact Ball Bearings



1. Design	2. Clearance	3. Cage Design	
A Non-filling slot (Conrad type - 3000, 5000 series) MRC. C.	C2 Axial clearance tighter than normal (3000,5000 and QJ series)	J Pressed steel cage, ball centred.	
B 40° contact angle	C3 Axial clearance greater than normal (3000, 5000 and QJ series)	M Machined brass cage, ball centred	
BE 40° contact angle, high capacity, all ISO corners	7000 Series clearance*	P Fibreglass reinforced polyamide, ball centred	
D Split inner ring (3300 series)	CA Modified for duplex mounting with axial clearance < normal	Y Press brass cage	
D MRC 29° contact angle, 1/2 pair, duplex	CB Modified for duplex mounting with normal axial clearance	4. Special Features	
DU MRC 29° contact angle and ground for duplex mounting and zero preload/ clearance	CC Modified for duplex mounting with axial clearance > normal	HC4 Full ceramic bearing	
E Filling slot (Max type - 5000 series) MRC. M.	CN Normal clearance (3000, 5000 series) no symbol shown	HC5 Ceramic ball set	
FF 2 Shields on MRC DRACBB	GA Modified for duplex mounting with light preload	5. Lubrication	
NR Snap ring (3300,5000 series)	GB Modified for duplex mounting with medium preload	MT33 Medium temperature Lithium grease, 74 cSt @ 40°C, range -30°C to + 120°C	
N2 Locating slot (QJ Series)	GC Modified for duplex mounting with heavy preload	GJN Di-urea hi-temp, 115cSt @ 40°C, range -40°C to +150°C	
R MRC single row with 15° contact angle	G... Special preload, value in daN		
RD MRC single row for duplex mounting and 15° contact angle	*If the above symbols from CA to G.. are not shown the bearing is not modified for duplex mounting		
2RS1 Rubber seals on both sides			
ZZ 2 rubber seals on MRC DRACBB			
ZZ Metal shields on both sides (5000 series)			

Angular contact ball bearings

Technical Features

	Single Row ACBB	Double Row ACBB	Four-Point Contact ACBB
Boundary Dimensions	In accordance with ISO 15-1998	In accordance with ISO 15-1998	In accordance with ISO 15-1998
Tolerances	ABEC 3 (P6) SKF Explorer P5 running P6 boundary	ABEC 3 (P6)*	ABEC 3 (P6)
Heat Stabilization	257°F (125°C) SKF Explorer 150°C	257°F (125°C) SKF Explorer 150°C	302°F (150°C)
Misalignment	None - contact SKF	None - contact SKF	None - contact SKF
Cage Materials	Polyamide (P)* Machined Brass (M)* Pressed Steel ¹⁾ J Pressed brass ¹⁾ (Y)	Polyamide (TN9) Limited sizes, pressed steel.	Machined Brass (M, MA)
Axial Load - max	1.4 x C ₀ for single or tandem mounted bearings 0.7 x C ₀ for duplex mounting	0.7 x C ₀ Conrad F _a /F _r ≤ 0.3	0.7 x C ₀
Seals, shields	Not available	2RS1- Nitrile rubber 2Z - Steel shields	Not available

*SKF Explorer types
¹⁾ Non-Explorer

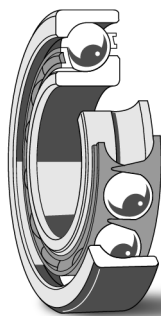

**Single Row
Angular Contact
Ball Bearing**
(data tables on page 78)

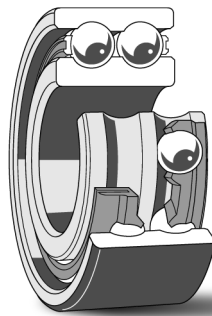

**Double Row
Angular Contact
Ball Bearing**
(data tables on page 91)

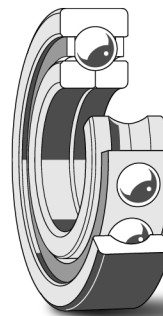

**Four-Point
Angular Contact
Ball Bearing**
(data tables on page 95)

Internal Clearance

Axial internal clearance single row angular contact ball bearings

Internal clearance in a single row angular contact ball bearing is only obtained after mounting and is dependent on adjustment against a second bearing that provides axial location in the opposite direction.

Bearings for universal pairing (suffix CB) are the standard SKF bearings for paired mounting in random order (back-to-back, face-to-face or tandem). Bearings can be supplied with smaller axial internal clearance (suffix CA) or larger (suffix CC) or with preload (suffixes GA, GB and GC) for universal pairing.

Bearings identified by suffix CA, CB or CC can be mounted immediately adjacent to each other in any order and two or more bearings may be used. Bearings with preload of the GA, GB and GC designs can only be arranged in pairs, otherwise the preload will increase.

The values of axial internal clearance for the classes CA, CB and CC can be found in **table 1**. They are valid for bearings arranged back-to-back or face-to-face before mounting and under zero measuring load. Preload values for classes GA, GB and GC are given in **table 1a**. **Table 2** shows a conversion from the old preload suffixes to the current suffix.

Bore diameter d over incl. mm	Axial internal clearance											
	CA				CB				CC			
	min	max	min	max	min	max	min	max	min	max	min	max
	μm		in		μm		in		μm		in	
- 10	4	12	0.0002	0.0005	14	22	0.0006	0.0009	22	30	0.0009	0.0012
10 18	5	13	0.0002	0.0005	15	23	0.0006	0.0009	24	32	0.0009	0.0013
18 30	7	15	0.0003	0.0006	18	26	0.0007	0.0010	32	40	0.0013	0.0016
30 50	9	17	0.0004	0.0007	22	30	0.0009	0.0012	40	48	0.0016	0.0019
50 80	11	23	0.0004	0.0009	26	38	0.0010	0.0015	48	60	0.0019	0.0024
80 120	14	26	0.0006	0.0010	32	44	0.0013	0.0017	55	67	0.0022	0.0026
120 180	17	29	0.0007	0.0011	35	47	0.0014	0.0019	62	74	0.0024	0.0029
180 250	21	37	0.0008	0.0015	45	61	0.0018	0.0024	74	90	0.0029	0.0035
250 315	26	42	0.0010	0.0017	52	68	0.0020	0.0027	90	106	0.0035	0.0042

Radial clearance [≈] 0.85 axial clearance.

Bore diameter d over incl. mm	Preload																							
	GA				GB				GC															
	min	max	min	max	max	max	min	max	min	max	min	max	min	max	min	max	min	max						
	μm		in		N		lbf		μm		in		N		lbf		μm		in		N		lbf	
10 18	4	-4	0.0002	-0.0002	80	18	-2	-10	-0.0001	-0.0004	30	330	7	74	-8	-16	-0.0003	-0.0006	230	660	52	149		
18 30	4	-4	0.0002	-0.0002	120	27	-2	-10	-0.0001	-0.0004	40	480	9	108	-8	-16	-0.0003	-0.0006	340	970	76	218		
30 50	4	-4	0.0002	-0.0002	160	36	-2	-10	-0.0001	-0.0004	60	630	13	142	-8	-16	-0.0003	-0.0006	450	1 280	101	288		
50 80	6	-6	0.0002	-0.0002	380	86	-3	-15	-0.0001	-0.0006	140	1 500	31	338	-12	-24	-0.0005	-0.0009	1 080	3 050	243	686		
80 120	6	-6	0.0002	-0.0002	410	92	-3	-15	-0.0001	-0.0006	150	1 600	34	360	-12	-24	-0.0005	-0.0009	1 150	3 250	259	731		
120 180	6	-6	0.0002	-0.0002	540	122	-3	-15	-0.0001	-0.0006	200	2 150	45	484	-12	-24	-0.0005	-0.0009	1 500	4 300	337	968		
180 250	8	-8	0.0003	-0.0003	940	212	-4	-20	-0.0002	-0.0008	330	3 700	74	833	-16	-32	-0.0006	-0.0013	2 650	7 500	596	1 688		
250 315	8	-8	0.0003	-0.0003	1 080	243	-4	-20	-0.0002	-0.0008	380	4 250	85	956	-16	-32	-0.0006	-0.0013	3 000	8 600	674	1 935		

Angular contact ball bearings

Table 2 Old/new preload designation interchange, single row angular contact ball bearings 72xx, 73xx and 74xx series

Bore size	Bore diameter (mm)	Old preload suffix					
		G02	G05	G1*	G2	G3	G5
00	10	GB	GB	GC	–	–	–
01	12	GB	GB	GC	–	–	–
02	15	GB	GB	GC	–	–	–
03	17	GB	GB	GC	–	–	–
04	20	GA	GB	GC	–	–	–
06	30	GA	GB	GC	–	–	–
07	35	GA	GB	GB	GC	–	–
08*	40*	GA	GB	GB*	GC	–	–
09	45	GA	GB	GB	GC	–	–
10	50	GA	GB	GB	GC	–	–
11	55	GA	GA	GB	GB	GB	GC
12	60	GA	GA	GB	GB	GB	GC
13	65	GA	GA	GB	GB	GB	GC
14	70	GA	GA	GB	GB	GB	GC
15	75	GA	GA	GB	GB	GB	GC
16	80	GA	GA	GB	GB	GB	GC
17	85	GA	GA	GB	GB	GB	GC
18	90	GA	GA	GB	GB	GB	GC
19	95	GA	GA	GB	GB	GB	GC
20	100	GA	GA	GB	GB	GB	GC
21	105	GA	GA	GB	GB	GB	GC
22	110	GA	GA	GB	GB	GB	GC
24	120	GA	GA	GB	GB	GB	GC
26	130	GA	GA	GB	GB	GB	GC
28	140	GA	GA	GB	GB	GB	GC
30	150	GA	GA	GB	GB	GB	GC
32	160	GA	GA	GB	GB	GB	GC
34	170	GA	GA	GB	GB	GB	GC
36	180	GA	GA	GB	GB	GB	GC

***Example:**

7308 BEAG1Y = 08 bore size,
40 mm bore diameter
G1 (100 lbs.) preload
Replace with: 7308 BEGBY

Table 3 Axial internal clearance of Conrad type and filling slot double row angular contact ball bearings 32, 33, 52, 53, 54 series and double row cam followers

Bore diameter d over incl. mm	Axial internal clearance															
	C2		Normal		C3		C4									
	min µm	max	min in	max	min µm	max	min in	max	min µm	max	min in	max	min µm	max	min in	max
- 10	1	11	0.0000	0.0004	5	21	0.0002	0.0008	12	28	0.0005	0.0011	40	60	0.0016	0.0024
10 18	1	12	0.0000	0.0005	6	23	0.0002	0.0009	13	31	0.0005	0.0012	42	64	0.0017	0.0025
18 24	2	14	0.0001	0.0006	7	25	0.0003	0.0010	16	34	0.0006	0.0013	43	69	0.0017	0.0027
24 30	2	15	0.0001	0.0006	8	27	0.0003	0.0011	18	37	0.0007	0.0015	45	75	0.0018	0.0030
30 40	2	16	0.0001	0.0006	9	29	0.0004	0.0011	21	40	0.0008	0.0016	48	84	0.0019	0.0033
40 50	2	18	0.0001	0.0007	11	33	0.0004	0.0013	23	44	0.0009	0.0017	51	90	0.0020	0.0035
50 65	3	22	0.0001	0.0009	13	36	0.0005	0.0014	26	48	0.0010	0.0019	55	96	0.0022	0.0038
65 80	3	24	0.0001	0.0009	15	40	0.0006	0.0016	30	54	0.0012	0.0021	61	106	0.0024	0.0042
80 100	3	26	0.0001	0.0010	18	46	0.0007	0.0018	35	63	0.0014	0.0025	70	123	0.0028	0.0048
100 110	4	30	0.0002	0.0012	22	53	0.0009	0.0021	42	73	0.0017	0.0029	80	148	0.0031	0.0058

Table 4 Axial internal clearance of four-point contact ball bearings

Bore diameter d				Axial internal clearance															
				C2				Normal				C3				C4			
over mm	incl. in	over in	incl. in	min μm	max μm	min in	max in	min μm	max μm	min in	max in	min μm	max μm	min in	max in	min μm	max μm	min in	max in
10	17	0.3937	0.6693	15	55	0.0006	0.0022	45	85	0.0018	0.0033	75	125	0.0030	0.0049	115	165	0.0045	0.0065
18	40	0.6693	1.5748	26	66	0.0010	0.0026	56	106	0.0022	0.0042	96	146	0.0038	0.0057	136	186	0.0054	0.0073
40	60	1.5748	2.3622	36	86	0.0014	0.0034	76	126	0.0030	0.0050	116	166	0.0046	0.0065	156	206	0.0061	0.0081
60	80	2.3622	3.1496	46	96	0.0018	0.0038	86	136	0.0034	0.0054	126	176	0.0050	0.0069	166	226	0.0065	0.0089
80	100	3.1496	3.9370	56	106	0.0022	0.0042	96	156	0.0038	0.0061	136	196	0.0054	0.0077	186	246	0.0073	0.0097
100	140	3.9370	5.5118	66	126	0.0026	0.005	116	176	0.0046	0.0069	156	216	0.0061	0.0085	206	266	0.0081	0.0105
140	180	5.5118	7.0866	76	156	0.0030	0.0061	136	196	0.0054	0.0077	176	246	0.0069	0.0097	226	296	0.0089	0.0116
180	220	7.0866	8.6614	96	176	0.0038	0.0069	156	226	0.0061	0.0089	206	276	0.0081	0.0109	256	326	0.0101	0.0128

Double row angular contact ball bearings

Basic design bearings in the 32 A and 33 A series shown in the product table as well as the corresponding sealed bearings to 2Z and 2RS1 design are identical to the corresponding bearings in the 52 and 53 series for the North American market. They have the same performance characteristics and dimensional features (except for the width of size 5200). However, the sealed bearings are filled with a different grease. Bearings in the 52 and 53 series use a mineral oil based high-temperature grease with di-urea thickener. The operating temperature range of this grease is -30 to +175°C. The base oil viscosity is 115 mm²/s at 40°C and 12 mm²/s at 100°C.

For 3200 and 3300 series, the grease has a lithium thickener with a mineral oil base. The operating temperature is -30°C to +120°C, with a base oil viscosity of 74mm²/s at 40°C

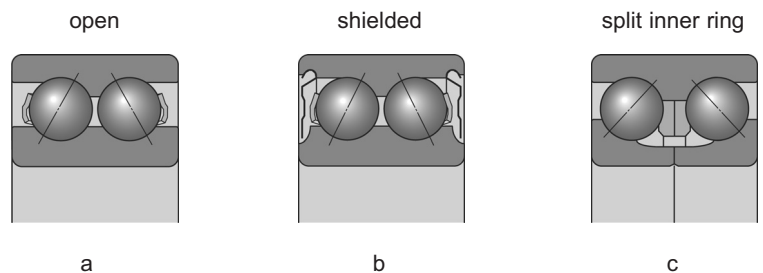

Single row angular contact ball bearings

d 10 - 35 mm

d 0.394 - 1.378 in

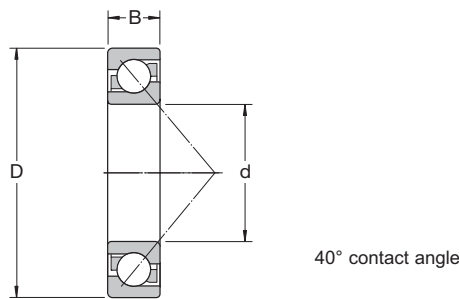

Principal dimensions						Basic load ratings		Fatigue load limit	Speed ratings		Mass	Designations	
d	D	B	d	D	B	C	C ₀	P _u	Reference speed	Limiting speed	kg	Universally matchable bearing	Basic design bearing
			in			kN		kN	r/min			-	
10	30	9	0.394	1.181	0.354	7.02	3.35	0.14	30 000	30 000	0.03	7200 BECBP	7200 BEP
12	32 37	10 12	0.472	1.260 1.457	0.394 0.472	7.61 10.6	3.8 5	0.16 0.208	26 000 24 000	26 000 24 000	0.036 0.063	7201 BECBP -	7201 BEP 7301 BEP
15	35 42	11 13	0.591	1.378 1.654	0.433 0.512	8.84 13	4.8 6.7	0.204 0.28	24 000 20 000	24 000 20 000	0.045 0.081	7202 BECBP 7302 BECBP	7202 BEP 7302 BEP
17	40 40 40 40 47	12 12 12 12 14	0.669	1.575 1.575 1.575 1.575 1.850	0.472 0.472 0.472 0.472 0.551	11 10.4 11.1 11 15.9	5.85 5.5 6.1 5.85 8.3	0.25 0.236 0.26 0.25 0.355	22 000 20 000 20 000 22 000 19 000	22 000 20 000 20 000 22 000 19 000	0.064 0.064 0.064 0.07 0.11	* 7203 BECBP - - * 7203 BECBM 7303 BECBP	- 7203 BEP 7203 BEY - 7303 BEP
20	47 47 47 52 52 52 52	14 14 14 15 15 15 15	0.787	1.850 1.850 1.850 2.047 2.047 2.047 2.047	0.551 0.551 0.551 0.591 0.591 0.591 0.591	14 14 13.3 19 17.4 19 19	8.3 8.3 7.65 10 9.5 10.4 10	0.355 0.355 0.325 0.425 0.4 0.44 0.425	18 000 18 000 18 000 18 000 16 000 16 000 18 000	18 000 18 000 19 000 18 000 16 000 16 000 18 000	0.11 0.11 0.11 0.14 0.14 0.15 0.15	7204 BECBP 7204 BECBY 7204 BECBM * 7304 BECBP - 7304 BECBY * 7304 BECBM	7204 BEP - - - 7304 BEP 7304 BEY -
25	52 52 52 52 62 62 62 62	15 15 15 15 17 17 17 17	0.984	2.047 2.047 2.047 2.047 2.441 2.441 2.441 2.441	0.591 0.591 0.591 0.591 0.669 0.669 0.669 0.669	15.6 14.8 15.6 15.6 26.5 24.2 26 26.5	10 9.3 10.2 10 15.3 14 15.6 15.3	0.43 0.4 0.43 0.43 0.655 0.6 0.655 0.655	17 000 15 000 15 000 17 000 15 000 14 000 14 000 15 000	17 000 15 000 15 000 17 000 15 000 14 000 14 000 15 000	0.13 0.13 0.13 0.14 0.23 0.23 0.24 0.24	* 7205 BECBP - 7205 BECBY * 7205 BECBM * 7305 BECBP - 7305 BECBY * 7305 BECBM	- 7205 BEP 7205 BEY - - 7305 BEP 7305 BEY -
30	62 62 62 62 72 72 72 72	16 16 16 16 19 19 19 19	1.181	2.441 2.441 2.441 2.441 2.835 2.835 2.835 2.835	0.630 0.630 0.630 0.630 0.748 0.748 0.748 0.748	24 22.5 23.8 24 35.5 32.5 34.5 35.5	15.6 14.3 15.6 15.6 21.2 19.3 21.2 21.2	0.655 0.61 0.655 0.655 0.9 0.815 0.9 0.9	14 000 13 000 13 000 14 000 13 000 12 000 12 000 13 000	14 000 13 000 13 000 14 000 13 000 12 000 12 000 13 000	0.19 0.19 0.21 0.21 0.33 0.33 0.37 0.37	* 7206 BECBP - 7206 BECBY * 7206 BECBM * 7306 BECBP - 7306 BECBY * 7306 BECBM	- 7206 BEP 7206 BEY - - 7306 BEP 7306 BEY -
35	72 72 72 72 80 80 80 80	17 17 17 17 21 21 21 21	1.378	2.835 2.835 2.835 2.835 3.150 3.150 3.150 3.150	0.669 0.669 0.669 0.669 0.827 0.827 0.827 0.827	31 29.1 30.7 31 41.5 39 39 41.5	20.8 19 20.8 20.8 26.5 24.5 24.5 26.5	0.88 0.815 0.88 0.88 1.14 1.04 1.04 1.14	12 000 11 000 11 000 11 000 11 000 10 000 10 000 11 000	12 000 11 000 11 000 12 000 11 000 10 000 10 000 11 000	0.28 0.28 0.3 0.3 0.45 0.45 0.49 0.49	* 7207 BECBP - 7207 BECBY * 7207 BECBM * 7307 BECBP - 7307 BECBY * 7307 BECBM	- 7207 BEP 7207 BEY - - 7307 BEP 7307 BEY -

* SKF Explorer bearing

Single row angular contact ball bearings

d 40 - 60 mm

d 1.575 - 2.362 in



Principal dimensions						Basic load ratings		Fatigue load limit P _u	Speed ratings		Mass	Designations	
d	D	B	d	D	B	dynamic	static		Reference speed	Limiting speed		Universally matchable bearing	Basic design bearing
			in				kN		kN	r/min	kg	–	
40	80	18	1.575	3.150	0.709	36.5	26	1.1	11 000	11 000	0.37	* 7208 BECBP	–
	80	18		3.150	0.709	34.5	24	1.02	10 000	10 000	0.37	–	7208 BEP
	80	18		3.150	0.709	36.4	26	1.1	10 000	10 000	0.38	7208 BECBY	7208 BEY
	80	18		3.150	0.709	36.5	26	1.1	11 000	11 000	0.39	* 7208 BECBM	–
	80	18		3.150	0.709	34.5	24	1.02	10 000	10 000	0.39	–	7208 BEM
	90	23		3.543	0.906	50	32.5	1.37	10 000	10 000	0.61	* 7308 BECBP	–
	90	23		3.543	0.906	46.2	30.5	1.13	9 000	9 000	0.61	–	7308 BEP
	90	23		3.543	0.906	49.4	33.5	1.4	9 000	9 000	0.64	7308 BECBY	7308 BEY
	90	23		3.543	0.906	50	32.5	1.37	10 000	10 000	0.68	* 7308 BECBM	–
45	85	19	1.772	3.346	0.748	38	28.5	1.22	10 000	10 000	0.42	* 7209 BECBP	–
	85	19		3.346	0.748	35.8	26	1.12	9 000	9 000	0.42	–	7209 BEP
	85	19		3.346	0.748	37.7	28	1.2	9 000	9 000	0.43	7209 BECBY	7209 BEY
	85	19		3.346	0.748	38	28.5	1.22	10 000	10 000	0.44	* 7209 BECBM	–
	100	25		3.937	0.984	61	40.5	1.73	9 000	9 000	0.82	* 7309 BECBP	–
	100	25		3.937	0.984	55.9	37.5	1.73	8 000	8 000	0.82	–	7309 BEP
	100	25		3.937	0.984	60.5	41.5	1.73	8 000	8 000	0.86	7309 BECBY	7309 BEY
	100	25		3.937	0.984	61	40.5	1.73	9 000	9 000	0.9	* 7309 BECBM	–
50	90	20	1.969	3.543	0.787	40	31	1.32	9 000	9 000	0.47	* 7210 BECBP	–
	90	20		3.543	0.787	37.7	28.5	1.22	8 500	8 500	0.47	–	7210 BEP
	90	20		3.543	0.787	39	30.5	1.29	8 500	8 500	0.47	7210 BECBY	7210 BEY
	90	20		3.543	0.787	40	31	1.32	9 000	9 000	0.51	* 7210 BECBM	–
	110	27		4.331	1.063	75	51	2.16	8 000	8 000	1.04	* 7310 BECBP	–
	110	27		4.331	1.063	68.9	47.5	2	7 500	7 500	1.04	–	7310 BEP
	110	27		4.331	1.063	74.1	51	2.2	7 500	7 500	1.13	7310 BECBY	7310 BEY
	110	27		4.331	1.063	75	51	2.16	8 000	8 000	1.16	* 7310 BECBM	–
55	100	21	2.165	3.937	0.827	48.8	38	1.63	7 500	7 500	0.62	7211 BECBP	7211 BEP
	100	21		3.937	0.827	48.8	38	1.63	7 500	7 500	0.62	7211 BECBY	7211 BEY
	100	21		3.937	0.827	46.2	36	1.53	7 500	8 000	0.66	7211 BECBM	–
55	120	29	2.165	4.724	1.142	85	60	2.55	7 000	7 000	1.34	* 7311 BECBP	–
	120	29		4.724	1.142	79.3	55	2.32	6 700	6 700	1.34	–	7311 BEP
	120	29		4.724	1.142	85.2	60	2.55	6 700	6 700	1.48	7311 BECBY	7311 BEY
	120	29		4.724	1.142	85	60	2.55	7 000	7 000	1.49	* 7311 BECBM	–
60	110	22	2.362	4.331	0.866	61	50	2.12	7 500	7 500	0.78	* 7212 BECBP	–
	110	22		4.331	0.866	57.2	45.5	1.93	7 000	7 000	0.78	–	7212 BEP
	110	22		4.331	0.866	57.2	45.5	1.93	7 000	7 000	0.83	7212 BECBY	7212 BEY
	110	22		4.331	0.866	61	50	2.12	7 500	7 500	0.85	* 7212 BECBM	–
	130	31		5.118	1.220	104	76.5	3.2	6 700	6 700	1.71	* 7312 BECBP	–
	130	31		5.118	1.220	95.6	69.5	3	6 000	6 000	1.71	–	7312 BEP
	130	31		5.118	1.220	95.6	69.5	3	6 000	6 000	1.75	7312 BECBY	7312 BEY
	130	31		5.118	1.220	104	76.5	3.2	6 700	6 700	1.88	* 7312 BECBM	–
	130	31		5.118	1.220	95.6	69.5	3	6 000	6 300	1.88	–	7312 BEM

* SKF Explorer bearing

Single row angular contact ball bearings

d 65 - 90 mm

d 2.559 - 3.543 in

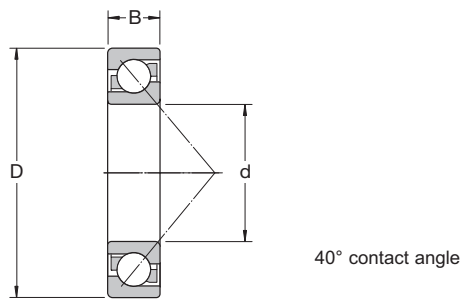

Principal dimensions						Basic load ratings		Fatigue load limit	Speed ratings		Mass	Designations	
d	D	B	d	D	B	C	C ₀	P _u	Reference speed	Limiting speed	kg	Universally matchable bearing	Basic design bearing
			in				kN		kN	r/min		-	
65	120	23	2.559	4.724	0.906	66.3	54	2.28	6 300	6 300	1	7213 BECBP	7213 BEP
	120	23		4.724	0.906	66.3	54	2.28	6 300	6 300	1	7213 BECBY	7213 BEY
	120	23	4.724	0.906	66.3	54	2.28	6 300	6 700	1.1	7213 BECBM	-	
	140	33	5.512	1.299	116	86.5	3.65	6 300	6 300	2.1	* 7313 BECBP	-	
	140	33	5.512	1.299	108	80	3.35	5 600	5 600	2.15	7313 BECBY	7313 BEP	
	140	33	5.512	1.299	116	86.5	3.65	6 300	6 300	2.31	* 7313 BECBM	-	
70	125	24	2.756	4.921	0.945	75	64	2.7	6 300	6 300	1.1	* 7214 BECBP	-
	125	24		4.921	0.945	71.5	60	2.5	6 000	6 000	1.1	7214 BECBY	7214 BEP
	125	24	4.921	0.945	72	60	2.55	6 300	6 300	1.18	* 7214 BECBM	-	
	150	35	5.906	1.378	127	98	3.9	5 600	5 600	2.55	* 7314 BECBP	-	
	150	35	5.906	1.378	119	90	3.65	5 300	5 300	2.67	7314 BECBY	7314 BEP	
	150	35	5.906	1.378	127	98	3.9	5 600	5 600	2.83	* 7314 BECBM	-	
75	130	25	2.953	5.118	0.984	72.8	64	2.65	5 600	5 600	1.18	7215 BECBP	7215 BEP
	130	25		5.118	0.984	72.8	64	2.65	5 600	5 600	1.26	7215 BECBY	-
	130	25	5.118	0.984	70.2	60	2.5	5 600	6 000	1.29	7215 BECBM	-	
	160	37	6.299	1.457	132	104	4.15	5 300	5 300	3.06	* 7315 BECBP	-	
	160	37	6.299	1.457	125	98	3.8	5 000	5 000	3.06	-	7315 BEP	
	160	37	6.299	1.457	133	106	4.15	5 000	5 000	3.2	7315 BECBY	-	
	160	37	6.299	1.457	132	104	4.15	5 300	5 300	3.26	* 7315 BECBM	-	
80	140	26	3.150	5.512	1.024	80.6	69.5	2.8	5 300	5 300	1.43	7216 BECBP	7216 BEP
	140	26		5.512	1.024	83.2	73.5	3	5 300	5 300	1.58	7216 BECBY	-
	140	26	5.512	1.024	85	75	3.05	5 600	5 600	1.59	* 7216 BECBM	-	
80	170	39	3.150	6.693	1.535	143	118	4.5	5 000	5 000	3.64	* 7316 BECBP	-
	170	39		6.693	1.535	135	110	4.15	4 500	4 500	3.64	-	7316 BEP
	170	39	6.693	1.535	143	118	4.5	4 500	4 500	3.7	7316 BECBY	7316 BEY	
	170	39	6.693	1.535	143	118	4.5	5 000	5 000	4.03	* 7316 BECBM	-	
	170	39	6.693	1.535	135	110	4.15	4 500	4 800	3.8	-	7316 BEM	
85	150	28	3.346	5.906	1.102	95.6	83	3.25	5 000	5 000	1.83	7217 BECBP	7217 BEP
	150	28		5.906	1.102	95.6	83	3.25	5 000	5 000	1.83	7217 BECBY	-
	150	28	5.906	1.102	95.6	83	3.25	5 000	5 300	1.99	7217 BECBM	-	
	180	41	7.087	1.614	156	132	4.9	4 800	4 800	4.26	* 7317 BECBP	-	
	180	41	7.087	1.614	146	112	4.5	4 300	4 300	4.26	-	7317 BEP	
	180	41	7.087	1.614	153	132	4.9	4 300	4 300	4.59	7317 BECBY	-	
	180	41	7.087	1.614	156	132	4.9	4 800	4 800	4.74	* 7317 BECBM	-	
	180	41	7.087	1.614	146	112	4.5	4 300	4 500	4.74	-	7317 BEM	
90	160	30	3.543	6.299	1.181	108	96.5	3.65	4 500	4 500	2.12	7218 BECBP	7218 BEP
	160	30		6.299	1.181	108	96.5	3.65	4 500	4 500	2.34	7218 BECBY	-
	160	30	6.299	1.181	108	96.5	3.65	4 500	4 800	2.41	7218 BECBM	-	
	190	43	7.480	1.693	166	146	5.3	4 500	4 500	4.98	* 7318 BECBP	-	
	190	43	7.480	1.693	156	134	4.8	4 000	4 000	4.98	-	7318 BEP	
	190	43	7.480	1.693	165	146	5.2	4 000	4 000	5.22	7318 BECBY	-	
	190	43	7.480	1.693	166	146	5.3	4 500	4 500	5.53	* 7318 BECBM	-	
	190	43	7.480	1.693	156	134	4.8	4 000	4 300	5.53	-	7318 BEM	

* SKF Explorer bearing

Single row angular contact ball bearings

d 95 - 180 mm
d 3.740 - 7.087 in



Principal dimensions						Basic load ratings		Fatigue load limit P _u	Speed ratings		Mass kg	Designations	
d	D	B	d	D	B	dynamic C	static C ₀		Reference speed	Limiting speed		Universally matchable bearing	Basic design bearing
			in				kN	kN	r/min				
95	170	32	3.740	6.693	1.260	124	108	4	4 300	4 300	2.68	7219 BECBP	7219 BEP
	170	32		6.693	1.260	124	108	4	4 300	4 300	2.82	7219 BECBy	–
	170	32	6.693	1.260	129	118	4.4	4 800	4 800	2.95	* 7219 BECBM	–	
	200	45	7.874	1.772	180	163	5.7	4 300	4 300	5.77	* 7319 BECBP	–	
	200	45	7.874	1.772	168	150	5.2	3 800	3 800	5.77	–	7319 BEP	
	200	45	7.874	1.772	178	163	5.6	3 800	3 800	6.17	7319 BECBy	–	
	200	45	7.874	1.772	180	163	5.7	4 300	4 300	6.41	* 7319 BECBM	–	
200	45	7.874	1.772	168	150	5.2	3 800	4 000	6.41	–	7319 BEM		
100	180	34	3.937	7.087	1.339	135	122	4.4	4 000	4 000	3.29	7220 BECBP	7220 BEP
	180	34		7.087	1.339	135	122	4.4	4 000	4 000	3.38	7220 BECBy	7220 BEY
	180	34	7.087	1.339	135	122	4.4	4 000	4 300	3.61	7220 BECBM	–	
	215	47	8.465	1.850	216	208	6.95	4 000	4 000	7.17	* 7320 BECBP	–	
	215	47	8.465	1.850	203	190	6.4	3 600	3 600	7.17	–	7320 BEP	
	215	47	8.465	1.850	203	190	6.4	3 600	3 600	7.15	7320 BECBy	7320 BEY	
	215	47	8.465	1.850	216	208	6.95	4 000	4 000	8	* 7320 BECBM	–	
215	47	8.465	1.850	203	190	6.4	3 600	3 800	8	–	7320 BEM		
105	190	36	4.134	7.480	1.417	148	137	4.8	3 800	3 800	3.82	7221 BECBP	7221 BEP
	190	36		7.480	1.417	148	137	4.8	3 800	4 000	4.18	7221 BECBM	–
	225	49	8.858	1.929	212	208	6.95	3 400	3 400	8.46	7321 BECBP	7321 BEP	
	225	49	8.858	1.929	203	193	6.4	3 400	3 600	9.12	7321 BECBM	–	
110	200	38	4.331	7.874	1.496	163	153	5.2	3 600	3 600	4.6	7222 BECBP	7222 BEP
	200	38		7.874	1.496	163	153	5.2	3 600	3 600	4.75	7222 BECBy	–
	200	38	7.874	1.496	153	143	4.9	3 600	3 800	4.95	7222 BECBM	7222 BEM	
	240	50	9.449	1.969	225	224	7.2	3 200	3 200	9.69	7322 BECBP	7322 BEP	
	240	50	9.449	1.969	225	224	7.2	3 200	3 200	9.69	7322 BECBy	7322 BEY	
	240	50	9.449	1.969	225	224	7.2	3 200	3 400	10.7	7322 BECBM	7322 BEM	
120	215	40	4.724	8.465	1.575	165	163	5.3	3 400	3 600	5.89	7224 BCBM	7224 BM
	260	55		10.236	2.165	238	250	7.65	3 000	3 200	13.8	7324 BCBM	–
130	230	40	5.118	9.055	1.575	186	193	6.1	3 200	3 400	6.76	7226 BCBM	7226 BM
	280	58		11.024	2.283	296	305	9	2 800	2 800	17.1	7326 BCBM	7326 BM
140	250	42	5.512	9.843	1.654	199	212	6.4	2 800	3 000	8.63	7228 BCBM	7228 BM
	300	62		11.811	2.441	302	345	9.8	2 600	2 600	21.3	7328 BCBM	–
150	270	45	5.906	10.630	1.772	216	240	6.95	2 600	2 800	10.8	7230 BCBM	–
	320	65		12.598	2.559	332	390	10.8	2 400	2 400	25	7330 BCBM	–
160	290	48	6.299	11.417	1.890	255	300	8.5	2 400	2 600	13.6	7232 BCBM	–
170	310	52	6.693	12.205	2.047	281	345	9.5	2 400	2 400	16.7	7234 BCBM	–
	360	72		14.173	2.835	390	490	12.7	2 000	2 200	34.6	7334 BCBM	–
180	320	52	7.087	12.598	2.047	291	375	10	2 200	2 400	17.6	7236 BCBM	–
	380	75		14.961	2.953	410	540	13.7	2 000	2 000	40	7336 BCBM	–

* SKF Explorer bearing

Single row angular contact ball bearings

d 190 - 240 mm

d 7.48 - 9.449 in

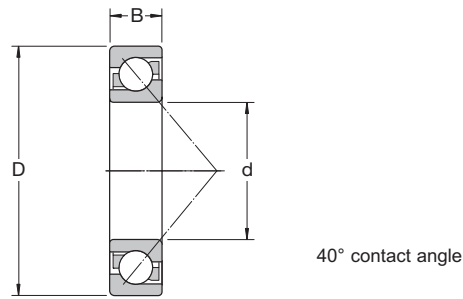

Principal dimensions						Basic load ratings		Fatigue load limit P_u	Speed ratings		Mass	Designations	
d	D	B	d	D	B	dynamic C	static C_0		Reference speed	Limiting speed		Universally matchable bearing	Basic design bearing
mm			in			kN		r/min		kg		-	
190	340	55	7.480	13.386	2.165	307	405	10.4	2 000	2 200	21.9	7238 BCBM	-
	400	78		15.748	3.071	442	600	14.6	1 900	1 900	48.3	7338 BCBM	-
200	360	58	7.874	14.173	2.283	325	430	11	1 800	2 000	25	7240 BCBM	-
	420	80		16.535	3.150	462	655	15.6	1 800	1 800	52.8	7340 BCBM	-
220	400	65	8.661	15.748	2.559	390	560	13.4	1 800	1 800	35.2	7244 BCBM	-
240	440	72	9.449	17.323	2.835	364	540	12.5	1 600	1 700	49	7248 BCBM	-

* SKF Explorer bearing

MRC 300-R Medium Series (Single bearings)

d 12 - 280 mm
d 0.4724 - 11.0236 in

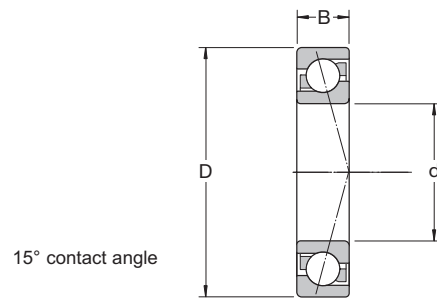

300-R Medium Series bearing bores range in diameter from 12 mm to 280 mm. They are used with heavy radial loads, one-directional thrust loads, or a combination of both. They can be furnished duplex ground for mounting in pairs with two-directional thrust loads.

MRC Bearing Number	Principal Dimensions			Basic Radial Load Rating			Speed Rating ¹⁾			
	d	D	B	d	D	B	Dynamic ²⁾	Static	Grease	Oil
	mm			in			kN	kN	rpm	
301-R	12	37	12	0.4724	1.4567	0.4727	10.600	4.900	19 000	24 000
302-R	15	42	13	0.5906	1.6535	0.5118	12.100	6.550	17 000	20 000
303-R	17	47	14	0.6693	1.8504	0.5512	14.800	8.150	16 000	19 000
304-R	20	52	15	0.7874	2.0472	0.5906	20.300	11.400	13 000	16 000
305-R	25	62	17	0.9843	2.4409	0.6693	23.400	15.300	11 000	14 000
306-R	30	72	19	1.1811	2.8346	0.748	31.200	20.000	9 000	11 000
307-R	35	80	21	1.3780	3.1496	0.8268	39.700	26.000	8 500	10 000
308-R	40	90	23	1.5748	3.5433	0.9055	48.800	33.500	7 500	9 000
309-R	45	100	25	1.7717	3.9370	0.9843	58.500	40.500	6 700	8 000
310-R	50	110	27	1.9685	4.3307	1.063	80.600	57.000	6 300	7 500
311-R	55	120	29	2.1654	4.7244	1.1417	93.600	67.000	5 600	6 700
312-R	60	130	31	2.3622	5.1181	1.2205	108.000	78.000	5 000	6 000
313-R	65	140	33	2.5591	5.5118	1.2992	121.000	93.000	4 800	5 600
314-R	70	150	35	2.7559	5.9055	1.378	121.000	93.000	4 500	5 300
315-R	75	160	37	2.9528	6.2992	1.4567	153.000	122.000	4 300	5 000
316-R	80	170	39	3.1496	6.6929	1.5354	159.000	129.000	3 800	4 500
317-R	85	180	41	3.3465	7.0866	1.6142	182.000	156.000	3 600	4 300
318-R	90	190	43	3.5433	7.4803	1.6929	186.000	160.000	3 400	4 000
319-R	95	200	45	3.7402	7.8740	1.7717	199.000	180.000	3 200	3 800
320-R	100	215	47	3.9370	8.4646	1.8504	212.000	200.000	3 000	3 600
321-R	105	225	49	4.1339	8.8583	1.9291	229.000	204.000	2 800	3 400
322-R	110	240	50	4.3307	9.4488	1.9685	255.000	255.000	2 600	3 200
324-R	120	260	55	4.7244	10.2362	2.1654	265.000	300.000	2 500	3 000
326-R	130	280	58	5.1181	11.0236	2.2835	296.000	345.000	2 300	2 800
328-R	140	300	62	5.5118	11.8110	2.4409	351.000	400.000	2 100	2 600
330-R	150	320	65	5.9055	12.5984	2.5591	390.000	475.000	2 000	2 400
332-R	160	340	68	6.2992	13.3858	2.6772	423.000	530.000	1 800	2 200
334-R	170	360	72	6.6929	14.1732	2.8346	436.000	570.000	1 700	2 100
336-R	180	380	75	7.0866	14.9606	2.9528	475.000	640.000	1 600	2 000
338-R	190	400	78	7.4803	15.7480	3.0709	507.000	710.000	1 600	1 900
340-R	200	420	80	7.8740	16.5354	3.1496	553.000	780.000	1 500	1 800
342-R	210	440	84	8.2677	17.3228	3.3071	592.000	865.000	1 400	1 700
344-R	220	460	88	8.6614	18.1102	3.4646	637.000	950.000	1 300	1 600
348-R	240	500	95	9.4488	19.6850	3.7402	676.000	1 060.000	1 100	1 400
352-R	260	540	102	10.2362	21.2598	4.0157	741.000	1 250.000	1 100	1 300
356-R	280	580	108	11.0236	22.8346	4.252	832.000	1 460.000	980	1 200

¹⁾ Listed values are for pressed steel or polyamide cage, ABEC-1.

For phenolic composition cage, multiply by 1.66 for grease and 2.00 for oil. For machined bronze cage, multiply by 1.25 for grease and 1.50 for oil. For phenolic composition cage, ABEC-5 or 7, multiply by 2.30 for grease and 2.80 for oil. The speed rating adjustment factors have been determined through historical application and practice.

²⁾ Rating for one million revolutions or 500 hours at 33 1/3 RPM.

MRC 300-RD medium series, duplex

d 12 - 280 mm

d 0.474 - 11.0236 in

"D" indicates a duplex ground half pair matched with an identical half pair and is followed by an additional suffix letter to describe the type of duplex.

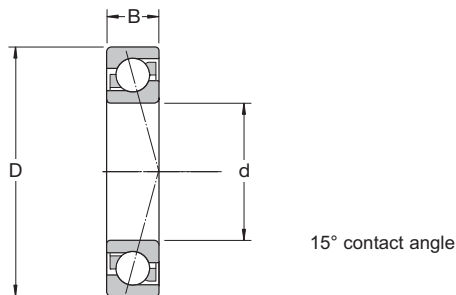

Note: ABEC 1 & 3 are stocked as half pairs where available.

Use these values for back-to-back (DB) or face-to-face (DF) mounting arrangements.

MRC Bearing Number	Principal Dimensions						Basic Radial Load Rating		Speed Rating ¹⁾	
	d	D	B	d	D	B	Dynamic ²⁾	Static	Grease	Oil
	mm			in			kN	kN	rpm	
301-RD	12	37	24	0.4724	1.4567	0.9449	17.2	9.8	15 000	19 000
302-RD	15	42	26	0.5906	1.6535	1.0236	19.9	12.9	14 000	16 000
303-RD	17	47	28	0.6693	1.8504	1.1024	23.8	16.3	13 000	15 000
304-RD	20	52	30	0.7874	2.0472	1.1811	32.5	22.4	10 000	13 000
305-RD	25	62	34	0.9843	2.4409	1.3386	37.7	30.5	8 800	11 000
306-RD	30	72	38	1.1811	2.8346	1.4961	50.7	40.0	7 200	8 800
307-RD	35	80	42	1.3780	3.1496	1.6535	63.7	52.0	6 800	8 000
308-RD	40	90	46	1.5748	3.5433	1.8110	79.3	67.0	6 000	7 200
309-RD	45	100	50	1.7717	3.9370	1.9685	95.6	81.5	5 400	6 400
310-RD	50	110	54	1.9685	4.3307	2.1260	133.0	114.0	5 000	6 000
311-RD	55	120	58	2.1654	4.7244	2.2835	153.0	134.0	4 500	5 400
312-RD	60	130	62	2.3622	5.1181	2.4409	174.0	156.0	4 000	4 800
313-RD	65	140	66	2.5591	5.5118	2.5984	195.0	190.0	3 800	4 500
314-RD	70	150	70	2.7559	5.9055	2.7559	199.0	190.0	3 600	4 200
315-RD	75	160	74	2.9528	6.2992	2.9134	247.0	245.0	3 400	4 000
316-RD	80	170	78	3.1496	6.6929	3.0709	255.0	260.0	3 000	3 600
317-RD	85	180	82	3.3465	7.0866	3.2283	291.0	310.0	2 900	3 400
318-RD	90	190	86	3.5433	7.4803	3.3858	302.0	325.0	2 700	3 200
319-RD	95	200	90	3.7402	7.8740	3.5433	325.0	360.0	2 600	3 000
320-RD	100	215	94	3.9370	8.4646	3.7008	345.0	400.0	2 400	2 900
321-RD	105	225	98	4.1339	8.8583	3.8583	371.0	415.0	2 200	2 700
322-RD	110	240	100	4.3307	9.4488	3.9370	416.0	510.0	2 100	2 600
324-RD	120	260	110	4.7244	10.2362	4.3307	436.0	600.0	2 000	2 400
326-RD	130	280	116	5.1181	11.0236	4.5669	475.0	695.0	1 800	2 200
328-RD	140	300	124	5.5118	11.8110	4.8819	572.0	800.0	1 700	2 100
330-RD	150	320	130	5.9055	12.5984	5.1181	624.0	950.0	1 600	1 900
332-RD	160	340	136	6.2992	13.3858	5.3543	689.0	1080.0	1 400	1 800
334-RD	170	360	144	6.6929	14.1732	5.6693	715.0	1140.0	1 400	1 700
336-RD	180	380	150	7.0866	14.9606	5.9055	780.0	1270.0	1 300	1 600
338-RD	190	400	156	7.4803	15.7480	6.1417	832.0	1430.0	1 300	1 500
340-RD	200	420	160	7.8740	16.5354	6.2992	904.0	1560.0	1 200	1 400
342-RD	210	440	168	8.2677	17.3228	6.6142	956.0	1730.0	1 100	1 400
344-RD	220	460	176	8.6614	18.1102	6.9291	1040.0	1900.0	1 000	1 300
348-RD	240	500	190	9.4488	19.6850	7.4803	1080	2120.0	880	1 100
352-RD	260	540	204	10.2362	21.2598	8.0315	1210	2500.0	880	1 000
356-RD	280	580	216	11.0236	22.8346	8.5039	1350	2900.0	780	960

¹⁾ Listed values are for pressed steel or polyamide cage, ABEC-1.

For phenolic composition cage, multiply by 1.66 for grease and 2.00 for oil. For machined bronze cage, multiply by 1.25 for grease and 1.50 for oil. For phenolic composition cage, ABEC-5 or 7, multiply by 2.30 for grease and 2.80 for oil. The speed rating adjustment factors have been determined through historical application and practice.

²⁾ Rating for one million revolutions or 500 hours at 33 1/3 RPM.

MRC 400-R and 400-RD Heavy Series, Duplex

d 17 - 110 mm
d 0.6693 - 4.3307 in

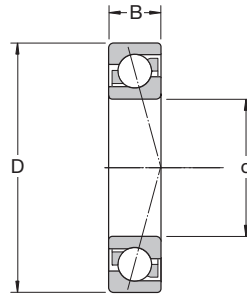

15° contact angle

400-R and -RD Heavy Series bearings are available in bores from 17 mm to 110 mm. They can handle very heavy radial loads, one-directional thrust loads, or a combination of both. Use duplex bearings for two-directional thrust loads.

"D" indicates a duplex ground half pair matched with an identical half pair and is followed by an additional suffix letter to describe the type of duplex.

Values for -RD bearings are for back-to-back (DB) or face-to-face (DF) mounting arrangements.

Note: ABEC 1 & 3 are stocked as half pairs where available.

MRC Bearing Number	Principal Dimensions						Basic Radial Load Rating		Speed Rating ¹⁾	
	d	D	B	d	D	B	Dynamic ²⁾	Static	Grease	Oil
	mm			in			kN	kN	rpm	
403-R	17	62	17	0.6693	2.4409	0.6693	23.4	14.6	12 000	15 000
404-R	20	72	19	0.7874	2.8346	0.7480	37.1	21.2	10 000	13 000
405-R	25	80	21	0.9843	3.1496	0.8268	44.9	26.5	9 000	11 000
406-R	30	90	23	1.1811	3.5433	0.9055	49.4	36.0	8 500	10 000
407-R	35	100	25	1.3780	3.9370	0.9843	58.5	44.0	7 000	8 500
408-R	40	110	27	1.5748	4.3307	1.0630	67.6	52.0	6 700	8 000
409-R	45	120	29	1.7717	4.7244	1.1417	78.0	61.0	6 000	7 000
410-R	50	130	31	1.9685	5.1181	1.2205	95.6	78.0	5 300	6 300
411-R	55	140	33	2.1654	5.5118	1.2992	108.0	90.0	5 000	6 000
412-R	60	150	35	2.3622	5.9055	1.3780	117.0	102.0	4 800	5 600
413-R	65	160	37	2.5591	6.2992	1.4567	127.0	112.0	4 500	5 300
414-R	70	180	42	2.7559	7.0866	1.6535	156.0	150.0	3 800	4 500
415-R	75	190	45	2.9528	7.4803	1.7717	168.0	166.0	3 600	4 300
416-R	80	200	48	3.1496	7.8740	1.8898	178.0	183.0	3 400	4 000
417-R	85	210	52	3.3465	8.2677	2.0472	190.0	200.0	3 200	3 800
418-R	90	225	54	3.5433	8.8583	2.1260	212.0	236.0	3 000	3 600
419-R	95	250	55	3.7402	9.8425	2.1654	234.0	275.0	2 700	3 300
420-R	100	265	60	3.9370	10.4331	2.3622	260.0	305.0	2 500	3 100
421-R	105	290	65	4.1339	11.4173	2.5591	286.0	355.0	2 400	2 900
422-R	110	320	70	4.3307	12.5984	2.7559	319.0	425.0	2 100	2 600
403-RD	17	62	34	0.6693	2.4409	1.3386	37.7	29.0	9 600	12 000
404-RD	20	72	38	0.7874	2.8346	1.4961	60.5	42.5	8 000	10 000
405-RD	25	80	42	0.9843	3.1496	1.6535	74.1	53.0	7 200	8 800
406-RD	30	90	46	1.1811	3.5433	1.8110	80.6	72.0	6 800	8 000
407-RD	35	100	50	1.3780	3.9370	1.9685	95.6	86.5	5 600	6 800
408-RD	40	110	54	1.5748	4.3307	2.1260	111.0	104.0	5 400	6 400
409-RD	45	120	58	1.7717	4.7244	2.2835	127.0	122.0	4 800	5 600
410-RD	50	130	62	1.9685	5.1181	2.4409	153.0	156.0	4 200	5 000
411-RD	55	140	66	2.1654	5.5118	2.5984	174.0	180.0	4 000	4 800
412-RD	60	150	70	2.3622	5.9055	2.7559	190.0	204.0	3 800	4 500
413-RD	65	160	74	2.5591	6.2992	2.9134	208.0	224.0	3 600	4 200
414-RD	70	180	84	2.7559	7.0866	3.3071	255.0	300.0	3 000	3 600
415-RD	75	190	90	2.9528	7.4803	3.5433	270.0	335.0	2 900	3 400
416-RD	80	200	96	3.1496	7.8740	3.7795	286.0	365.0	2 700	3 200
417-RD	85	210	104	3.3465	8.2677	4.0945	307.0	400.0	2 600	3 000
418-RD	90	225	108	3.5433	8.8583	4.2520	345.0	465.0	2 400	2 900
419-RD	95	250	110	3.7402	9.8425	4.3307	377.0	550.0	2 200	2 600
420-RD	100	265	120	3.9370	10.4331	4.7244	416.0	610.0	2 000	2 500
421-RD	105	290	130	4.1339	11.4173	5.1181	462.0	710.0	1 900	2 300
422-RD	110	320	140	4.3307	12.5984	5.5118	520.0	850.0	1 700	2 100

¹⁾ Listed values are for pressed steel or polyamide cage, ABEC-1.

For phenolic composition cage, multiply by 1.66 for grease and 2.00 for oil. For machined bronze cage, multiply by 1.25 for grease and 1.50 for oil. For phenolic composition cage, ABEC-5 or 7, multiply by 2.30 for grease and 2.80 for oil. The speed rating adjustment factors have been determined through historical application and practice.

²⁾ Rating for one million revolutions or 500 hours at 33 1/3 RPM.

MRC 7200 Light Series (single bearings)

d 10 - 320 mm

d 0.3937 - 12.5984 in

The 7200 Series contains single-row angular contact bearings with a counterbored outer ring. Bore sizes range from 10 mm to 320 mm, and most of these bearings are available with a two-piece pressed steel cage, or a one-piece nonmetallic or solid bronze cage. 7000 Series bearings are designed with an initial contact angle of 29 degrees, although some small sizes may have a lesser angle. 7200 Series bearings can be used with moderate to heavy one-directional thrust loads, or combined radial and thrust loads where the thrust load is predominant.

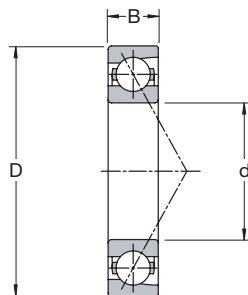

29° contact angle

Caution: Single bearings are not to be used where only radial loads are present. For two-directional thrust loads, use duplex bearings.

MRC Bearing Number	Principal Dimensions						Basic Radial ¹⁾ Load Rating		Speed Rating ²⁾	
	d	D	B	d	D	B	C ³⁾	C ₀	Grease	Oil
	mm			in			kN	kN	rpm	
7200	10	30	9	0.3937	1.1811	0.3543	5.40	2.75	28 000	36 000
7201	12	32	10	0.4724	1.2598	0.3937	6.24	3.20	22 000	29 000
7202	15	35	11	0.5906	1.3780	0.4331	9.04	4.75	20 000	26 000
7203	17	40	12	0.6693	1.5748	0.4724	11.9	6.6	18 000	23 000
7204	20	47	14	0.7874	1.8504	0.5512	12.7	7.2	15 000	19 000
7205	25	52	15	0.9843	2.0472	0.5906	15.3	9.5	12 000	16 000
7206	30	62	16	1.1811	2.4409	0.6299	16.8	11.8	10 000	13 000
7207	35	72	17	1.3780	2.8346	0.6693	23.4	17.0	9 200	12 000
7208	40	80	18	1.5748	3.1496	0.7087	30.7	22.8	7 700	10 000
7209	45	85	19	1.7717	3.3465	0.7480	30.7	23.2	7 300	9 500
7210	50	90	20	1.9685	3.5433	0.7874	33.2	27.0	6 400	8 300
7211	55	100	21	2.1654	3.9370	0.8268	48.8	37.5	6 000	7 800
7212	60	110	22	2.3622	4.3307	0.8661	52.7	44.0	5 400	7 000
7213	65	120	23	2.5591	4.7244	0.9055	63.7	54.0	4 900	6 400
7214	70	125	24	2.7559	4.9213	0.9449	63.7	55.0	4 600	6 000
7215	75	130	25	2.9528	5.1181	0.9843	79.3	69.5	4 300	5 600
7216	80	140	26	3.1496	5.5118	1.0236	74.1	67.0	4 100	5 300
7217	85	150	28	3.3465	5.9055	1.1024	90.4	83.0	3 800	4 900
7218	90	160	30	3.5433	6.2992	1.1811	117.0	118.0	3 600	4 700
7219	95	170	32	3.7402	6.6929	1.2598	121.0	114.0	3 500	4 500
7220	100	180	34	3.9370	7.0866	1.3386	138.0	129.0	3 200	4 100
7221	105	190	36	4.1339	7.4803	1.4173	148.0	137.0	3 000	3 900
7222	110	200	38	4.3307	7.8740	1.4961	163.0	156.0	2 900	3 800
7224	120	215	40	4.7244	8.4646	1.5748	174.0	176.0	2 700	3 500
7226	130	230	40	5.1181	9.0551	1.5748	195.0	208.0	2 500	3 200
7228	140	250	42	5.5118	9.8425	1.6535	208.0	232.0	2 300	3 000
7230	150	270	45	5.9055	10.6299	1.7717	242.0	280.0	2 100	2 700
7232	160	290	48	6.2992	11.4173	1.8898	270.0	325.0	2 000	2 600
7234	170	310	52	6.6929	12.2047	2.0472	286.0	365.0	1 900	2 500
7236	180	320	52	7.0866	12.5984	2.0472	302.0	390.0	1 900	2 400
7238	190	340	55	7.4803	13.3858	2.1654	332.0	450.0	1 700	2 200
7240	200	360	58	7.8740	14.1732	2.2835	351.0	490.0	1 600	2 100
7242	210	380	61	8.2677	14.9606	2.4016	390.0	560.0	1 500	2 000
7244	220	400	65	8.6614	15.7480	2.5591	403.0	600.0	1 500	2 000
7246	230	420	68	9.0551	16.5354	2.6772	442.0	670.0	1 500	1 900
7248	240	440	72	9.4488	17.3228	2.8346	475.0	750.0	1 400	1 800
7250	250	460	76	9.8425	18.1102	2.9921	520.0	830.0	1 400	1 800
7252	260	480	80	10.2362	18.8976	3.1496	559.0	915.0	1 300	1 700
7256	280	500	80	11.0236	19.6850	3.1496	572.0	980.0	1 300	1 700
7260	300	540	85	11.8110	21.2598	3.3465	618.0	1100.0	1 200	1 600
7264	320	580	92	12.5984	22.8346	3.6220	650.0	1220.0	1 200	1 500

1) For thrust rating multiply C by 1.32 and C₀ by 2.94.

2) Listed values are for machined bronze cage, ABEC-1.

For phenolic composition cage, multiply by 1.33 for both grease and oil. For phenolic composition cage, ABEC-5 or 7, multiply by 1.86 for both grease and oil. For pressed steel cage, ABEC-1, multiply by 0.67 for grease and 0.80 for oil. The speed rating adjustment factors have been determined through historical application and practice.

3) Rating for one million revolutions or 500 hours at 33 1/3 RPM.

MRC 7200-D light series, duplex

d 10 - 320 mm

d 0.3937 - 12.5984 in

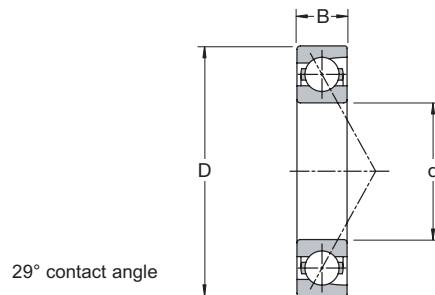

"D" indicates a duplex ground half pair matched with an identical half pair and is followed by an additional suffix letter to describe the type of duplex.

Use these values for back-to-back (DB) or face-to-face (DF) mounting arrangements.

Note: ABEC 1 & 3 are stocked as half pairs, where available.

MRC Bearing Number	Principal Dimensions			Basic Radial ¹⁾ Load Rating			Speed Rating ²⁾			
	d	D	B	d	D	B	C ³⁾	C ₀	Grease	Oil
	mm			in			kN	kN	rpm	
7200-D	10	30	18	0.3937	1.1811	0.7087	8.8	5.5	22 000	29 000
7201-D	12	32	20	0.4724	1.2598	0.7874	10.1	6.4	18 000	23 000
7202-D	15	35	22	0.5906	1.3780	0.8661	14.8	9.5	16 000	21 000
7203-D	17	40	24	0.6693	1.5748	0.9449	19.5	13.2	14 000	18 000
7204-D	20	47	28	0.7874	1.8504	1.1024	20.8	14.6	12 000	15 000
7205-D	25	52	30	0.9843	2.0472	1.1811	25.1	19.0	9 600	13 000
7206-D	30	62	32	1.1811	2.4409	1.2598	27.6	23.6	8 000	10 000
7207-D	35	72	34	1.3780	2.8346	1.3386	37.7	34.0	7 400	9 600
7208-D	40	80	36	1.5748	3.1496	1.4173	49.4	45.5	6 200	8 000
7209-D	45	85	38	1.7717	3.3465	1.4961	49.4	46.5	5 800	7 600
7210-D	50	90	40	1.9685	3.5433	1.5748	54.0	54.0	5 100	6 600
7211-D	55	100	42	2.1654	3.9370	1.6535	79.3	75.0	4 800	6 200
7212-D	60	110	44	2.3622	4.3307	1.7323	85.2	88.0	4 300	5 600
7213-D	65	120	46	2.5591	4.7244	1.8110	104.0	110.0	3 900	5 100
7214-D	70	125	48	2.7559	4.9213	1.8898	104.0	110.0	3 700	4 800
7215-D	75	130	50	2.9528	5.1181	1.9685	130.0	140.0	3 400	4 500
7216-D	80	140	52	3.1496	5.5118	2.0472	121.0	134.0	3 300	4 200
7217-D	85	150	56	3.3465	5.9055	2.2047	148.0	166.0	3 000	3 900
7218-D	90	160	60	3.5433	6.2992	2.3622	190.0	236.0	2 900	3 800
7219-D	95	170	64	3.7402	6.6929	2.5197	199.0	228.0	2 800	3 600
7220-D	100	180	68	3.9370	7.0866	2.6772	225.0	260.0	2 600	3 300
7221-D	105	190	72	4.1339	7.4803	2.8346	242.0	295.0	2 400	3 100
7222-D	110	200	76	4.3307	7.8740	2.9921	265.0	310.0	2 300	3 000
7224-D	120	215	80	4.7244	8.4646	3.1496	281.0	355.0	2 200	2 800
7226-D	130	230	80	5.1181	9.0551	3.1496	319.0	415.0	2 000	2 600
7228-D	140	250	84	5.5118	9.8425	3.3071	338.0	465.0	1 800	2 400
7230-D	150	270	90	5.9055	10.6299	3.5435	397.0	560.0	1 700	2 200
7232-D	160	290	96	6.2992	11.4173	3.7795	442.0	670.0	1 600	2 100
7234-D	170	310	104	6.6929	12.2047	4.0945	468.0	735.0	1 500	2 000
7236-D	180	320	104	7.0866	12.5984	4.0945	494.0	780.0	1 500	1 900
7238-D	190	340	110	7.4803	13.3858	4.3307	540.0	900.0	1 400	1 800
7240-D	200	360	116	7.8740	14.1732	4.5669	572.0	965.0	1 300	1 700
7242-D	210	380	122	8.2677	14.9606	4.8031	637.0	1120.0	1 200	1 600
7244-D	220	400	130	8.6614	15.7480	5.1181	650.0	1200.0	1 200	1 600
7246-D	230	420	136	9.0551	16.5354	5.3543	715.0	1340.0	1 200	1 500
7248-D	240	440	144	9.4488	17.3228	5.6693	780.0	1500.0	1 100	1 400
7250-D	250	460	152	9.8425	18.1102	5.9842	852.0	1660.0	1 100	1 400
7252-D	260	480	160	10.2362	18.8976	6.2992	904.0	1830.0	1 000	1 400
7256-D	280	500	160	11.0236	19.6850	6.2992	936.0	2000.0	1 000	1 400
7260-D	300	540	170	11.8110	21.2598	6.6929	1010.0	2200.0	960	1 300
7264-D	320	580	184	12.5984	22.8346	7.2441	1060.0	2400.0	960	1 200

1) For thrust rating multiply C by 0.81 and C₀ by 1.47.

2) Listed values are for machined bronze cage, ABEC-1.

For phenolic composition cage, multiply by 1.33 for both grease and oil. For phenolic composition cage, ABEC-5 or 7, multiply by 1.86 for both grease and oil. For pressed steel cage, ABEC-1, multiply by 0.67 for grease and 0.80 for oil. The speed rating adjustment factors have been determined through historical application and practice.

3) Rating for one million revolutions or 500 hours at 33 1/3 RPM.

MRC 7300 Medium Series (Single bearings)

d 10 - 280 mm

d 0.3937 - 11.0236 in

7300 series bearings have the same ring and ball cage construction as the 7200 Series but are heavier sectioned bearings with a ball complement capable of handling heavier loads. 7300 Series are listed with bore sizes from 10 mm to 280 mm. For two directional thrust loads, use duplex bearings.

Caution: Single bearings are not to be used where only radial loads are present. For two-direction thrust loads, use duplex bearings.

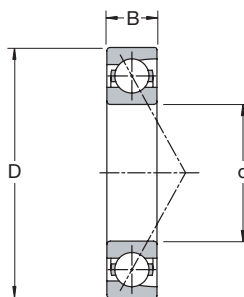

29° contact angle

MRC Bearing Number	Principal Dimensions						Basic Radial ¹⁾ Load Rating		Speed Rating ²⁾	
	d	D	B	d	D	B	C ³⁾	C ₀	Grease	Oil
	mm			in			kN	kN	rpm	
7300	10	36	11	0.3937	1.3780	.4331	6.37	3.20	24 000	31 000
7301	12	37	12	0.4724	1.4567	0.4724	7.02	3.75	19 000	25 000
7302	15	42	13	0.5906	1.6535	0.5118	13.50	7.10	16 000	21 000
7303	17	47	14	0.6693	1.8504	0.5512	15.9	8.65	15 000	19 000
7304	20	52	15	0.7874	2.0472	0.5906	18.6	10.6	13 000	17 000
7305	25	62	17	0.9843	2.4409	0.6693	21.2	13.7	11 000	14 000
7306	30	72	19	1.1811	2.8346	0.7480	28.1	18.6	9 200	12 000
7307	35	80	21	1.3780	3.1496	0.8268	35.8	24.0	8 500	11 000
7308	40	90	23	1.5748	3.5433	0.9055	44.2	30.5	7 300	9 500
7309	45	100	25	1.7717	3.9370	0.9843	52.7	37.5	6 400	8 300
7310	50	110	27	1.9685	4.3307	1.0630	74.1	53.0	5 800	7 500
7311	55	120	29	2.1654	4.7244	1.1417	85.2	62.0	5 100	6 600
7312	60	130	31	2.3622	5.1181	1.2205	97.5	72.0	4 900	6 400
7313	65	140	33	2.5591	5.5118	1.2992	108.0	86.5	4 600	6 000
7314	70	150	35	2.7559	5.9055	1.3780	111.0	85.0	4 100	5 300
7315	75	160	37	2.9528	6.2992	1.4567	138.0	114.0	3 900	5 000
7316	80	170	39	3.1496	6.6929	1.5354	143.0	120.0	3 600	4 700
7317	85	180	41	3.3465	7.0866	1.6142	163.0	143.0	3 500	4 500
7318	90	190	43	3.5433	7.4803	1.6299	168.0	150.0	3 200	4 200
7319	95	200	45	3.7402	7.8740	1.7717	178.0	166.0	3 100	4 000
7320	100	215	47	3.9370	8.4646	1.8504	190.0	183.0	3 000	3 900
7321	105	225	49	4.1339	8.8583	1.9291	203.0	200.0	2 900	3 800
7322	110	240	50	4.3307	9.4488	1.9685	229.0	236.0	2 700	3 500
7324	120	260	55	4.7244	10.2362	2.1654	260.0	275.0	2 500	3 200
7326	130	280	58	5.1181	11.0236	2.2835	286.0	320.0	2 300	3 000
7328	140	300	62	5.5118	11.8110	2.4409	312.0	375.0	2 200	2 800
7330	150	320	65	5.9055	12.5984	2.5591	345.0	430.0	2 000	2 600
7332	160	340	68	6.2992	13.3858	2.6772	377.0	490.0	1 900	2 500
7334	170	360	72	6.6929	14.1732	2.8346	397.0	520.0	1 900	2 400
7336	180	380	75	7.0866	14.9606	2.9528	423.0	585.0	1 800	2 300
7338	190	400	78	7.4803	15.7480	3.0709	462.0	655.0	1 600	2 100
7340	200	420	80	7.8740	16.5354	3.1496	494.0	720.0	1 500	2 000
7342	210	440	84	8.2677	17.3228	3.3071	527.0	800.0	1 500	1 900
7344	220	460	88	8.6614	18.1102	3.4646	559.0	865.0	1 400	1 800
7348	240	500	95	9.4488	19.6850	3.7402	605.0	965.0	1 400	1 700
7352	260	540	102	10.2362	21.2598	4.0157	663.0	1140.0	1 300	1 600
7356	280	580	108	11.0236	22.8346	4.2520	741.0	1340.0	1 200	1 500

1) For thrust rating multiply C by 1.32 and C₀ by 2.94

2) Listed values are for machined bronze cage, ABEC-1.

For phenolic composition cage, multiply by 1.33 for both grease and oil. For phenolic composition cage, ABEC-5 or 7, multiply by 1.86 for both grease and oil. For pressed steel cage, ABEC-1, multiply by 0.67 for grease and 0.80 for oil. The speed rating adjustment factors have been determined through historical application and practice.

3) Rating for one million revolutions or 500 hours at 33 1/3 RPM.

MRC 7300-D medium series, duplex

d 10 - 280 mm

d 0.3937 - 11.0236 in

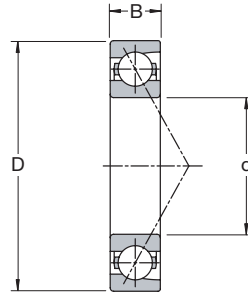

29° contact angle

"D" indicates a duplex ground half pair matched with an identical half pair and is followed by an additional suffix letter to describe the type of duplex.

Use these values for back-to-back (DB) or face-to-face (DF) mounting arrangements.

Note: ABEC 1 & 3 are stocked as half pairs where available.

MRC Bearing Number	Principal Dimensions						Basic Radial ¹⁾ Load Rating		Speed Rating ²⁾	
	d	D	B	d	D	B	C ³⁾	C ₀	Grease	Oil
	mm			in			kN	kN	rpm	
7300-D 10	36	22	0.3937	1.3780	0.8661	10.4	6.4	19 000	25 000	
7301-D 12	37	24	0.4724	1.4567	0.9449	11.4	7.5	15 000	20 000	
7302-D 15	42	26	0.5906	1.6535	1.0236	21.6	14.3	13 000	17 000	
7303-D 17	47	28	0.6693	1.8504	1.1024	26.0	17.3	12 000	15 000	
7304-D 20	52	30	0.7874	2.0472	1.1811	30.2	21.2	10 000	14 000	
7305-D 25	62	34	0.9843	2.4409	1.3386	34.5	27.0	8 800	11 000	
7306-D 30	72	38	1.1811	2.8346	1.4961	46.2	37.5	7 400	9 600	
7307-D 35	80	42	1.3780	3.1496	1.6535	58.5	48.0	6 800	8 800	
7308-D 40	90	46	1.5748	3.5433	1.8110	71.5	61.0	5 800	7 600	
7309-D 45	100	50	1.7717	3.9370	1.9685	85.2	75.0	5 100	6 600	
7310-D 50	110	54	1.9685	4.3307	2.1260	121.0	106.0	4 600	6 000	
7311-D 55	120	58	2.1654	4.7244	2.2835	140.0	125.0	4 100	5 300	
7312-D 60	130	62	2.3622	5.1181	2.4409	159.0	146.0	3 900	5 100	
7313-D 65	140	66	2.5591	5.5118	2.5984	178.0	173.0	3 700	4 800	
7314-D 70	150	70	2.7559	5.9055	2.7559	182.0	170.0	3 300	4 200	
7315-D 75	160	74	2.9528	6.2992	2.9134	225.0	228.0	3 100	4 000	
7316-D 80	170	78	3.1496	6.6929	3.0709	234.0	240.0	2 900	3 800	
7317-D 85	180	82	3.3465	7.0866	3.2283	265.0	285.0	2 800	3 600	
7318-D 90	190	86	3.5433	7.4803	3.3858	276.0	300.0	2 600	3 400	
7319-D 95	200	90	3.7402	7.8740	3.5433	291.0	325.0	2 500	3 200	
7320-D 100	215	94	3.9370	8.4646	3.7008	312.0	365.0	2 400	3 100	
7321-D 105	225	98	4.1339	8.8583	3.8583	332.0	400.0	2 300	3 000	
7322-D 110	240	100	4.3307	9.4488	3.9370	371.0	475.0	2 200	2 800	
7324-D 120	260	110	4.7244	10.2362	4.3307	423.0	560.0	2 000	2 600	
7326-D 130	280	116	5.1181	11.0236	4.5669	468.0	640.0	1 800	2 400	
7328-D 140	300	124	5.5118	11.8110	4.8819	507.0	735.0	1 800	2 200	
7330-D 150	320	130	5.9055	12.5984	5.1181	559.0	865.0	1 600	2 100	
7332-D 160	340	136	6.2992	13.3858	5.3543	618.0	965.0	1 500	2 000	
7334-D 170	360	144	6.6929	14.1732	5.6693	650.0	1040.0	1 500	1 900	
7336-D 180	380	150	7.0866	14.9606	5.9055	689.0	1160.0	1 400	1 800	
7338-D 190	400	156	7.4803	15.748	6.1417	761.0	1290.0	1 300	1 700	
7340-D 200	420	160	7.8740	16.5354	6.2992	806.0	1430.0	1 200	1 600	
7342-D 210	440	168	8.2677	17.3228	6.6142	852.0	1600.0	1 200	1 500	
7344-D 220	460	176	8.6614	18.1102	6.9291	904.0	1730.0	1 100	1 400	
7348-D 240	500	190	9.4488	19.6850	7.4803	975.0	1930.0	1 000	1 400	
7352-D 260	540	204	10.2362	21.2598	8.0315	1080.0	2280.0	960	1 300	
7356-D 280	580	216	11.0236	22.8346	8.5309	1210.0	2650.0	960	1 200	

1) For thrust rating multiply C by 0.81 and C₀ by 1.47.

2) Listed values are for machined bronze cage, ABEC-1.

For phenolic composition cage, multiply by 1.33 for both grease and oil. For phenolic composition cage, ABEC-5 or 7, multiply by 1.86 for both grease and oil. For pressed steel cage, ABEC-1, multiply by 0.67 for grease and 0.80 for oil. The speed rating adjustment factors have been determined through historical application and practice.

3) Rating for one million revolutions or 500 hours at 33 1/3 RPM.

MRC 7400 heavy series and MRC 7400-D heavy series

d 17 - 110 mm

d 0.6693 - 4.3307 in

7400 Series bearings are similar to the 7200 and 7300 Series but are heavier sectioned and are used for heavy one-directional thrust loads or combined radial and thrust loads where the thrust load is predominant.

"D" indicates a duplex ground half pair matched with an identical half pair and if followed by an additional suffix letter to describe the type of duplex.

Caution: Single bearings are not to be used where only radial loads are present. For two-direction thrust loads, use duplex bearings.

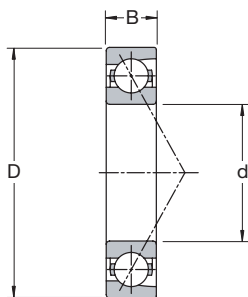

29° contact angle

Note: ABEC 1 & 3 are stocked as half pairs where available.

Values for -D bearings are for back-to-back (DB) or face-to-face (DF) mounting arrangements.

MRC Bearing Number	Principal Dimensions						Basic Radial ¹⁾ Load Rating		Speed Rating ²⁾	
	d	D	B	d	D	B	C ³⁾	C ₀	Grease	Oil
	mm			in			kN	kN	rpm	
7403	17	62	17	0.6693	2.4409	0.6693	26.0	13.7	14 000	18 000
7404	20	72	19	0.7874	2.8346	0.748	32.5	17.6	12 000	15 000
7405	25	80	21	0.9843	3.1496	0.8268	42.3	24.5	9 200	12 000
7406	30	90	23	1.1811	3.5433	0.9055	54.0	34.0	7 700	10 000
7407	35	100	25	1.3780	3.937	0.9843	63.7	40.5	6 600	8 500
7408	40	110	27	1.5748	4.3307	1.063	74.1	49.0	5 400	7 700
7409	45	120	29	1.7717	4.7244	1.1417	85.2	57.0	5 300	6 900
7410	50	130	31	1.9685	5.1181	1.2205	95.6	72.0	4 900	6 400
7411	55	140	33	2.1654	5.5118	1.2992	108.0	78.0	4 500	5 800
7412	60	150	35	2.3622	5.9055	1.378	127.0	93.0	4 100	5 300
7413	65	160	37	2.5591	6.2992	1.4567	138.0	106.0	3 800	4 900
7414	70	180	42	2.7559	7.0866	1.6535	168.0	140.0	3 500	4 600
7415	75	190	45	2.9528	7.4803	1.7717	182.0	156.0	3 300	4 300
7416	80	200	48	3.1496	7.874	1.8898	190.0	170.0	3 200	4 100
7417	85	210	52	3.3465	8.2677	2.0472	203.0	186.0	2 900	3 800
7418	90	225	54	3.5433	8.8583	2.126	229.0	220.0	2 700	3 500
7419	95	250	55	3.7402	9.8425	2.1654	255.0	255.0	2 500	3 300
7420	100	265	60	9.9370	10.4331	2.3622	276.0	290.0	2 400	3 200
7421	105	290	65	4.1339	11.4173	2.5591	332.0	325.0	2 300	3 000
7422	110	320	70	4.3307	12.5984	2.7559	371.0	390.0	2 200	2 900
7403-D	17	62	34	0.6693	2.4409	1.3386	42.3	27.0	11 000	14 000
7404-D	20	72	38	0.7874	2.8346	1.4961	52.7	35.5	9 600	12 000
7405-D	25	80	42	0.9843	3.1496	1.6535	68.9	49.0	7 400	9 600
7406-D	30	90	46	1.1811	3.5433	1.811	88.4	68.0	6 200	8 000
7407-D	35	100	50	1.3780	3.937	1.9685	104.0	81.5	5 300	6 800
7408-D	40	110	54	1.5748	4.3307	2.126	121.0	96.5	4 300	6 200
7409-D	45	120	58	1.7717	4.7244	2.2835	138.0	114.0	4 200	5 500
7410-D	50	130	62	1.9685	5.1181	2.4409	156.0	146.0	3 900	5 100
7411-D	55	140	66	2.1654	5.5118	2.5984	178.0	156.0	3 600	4 600
7412-D	60	150	70	2.3622	5.9055	2.7559	203.0	190.0	3 300	4 200
7413-D	65	160	74	2.5591	6.2992	2.9134	225.0	275.0	3 000	3 900
7414-D	70	180	84	2.7559	7.0866	3.3071	276.0	280.0	2 800	3 700
7415-D	75	190	90	2.9528	7.4803	3.5433	291.0	310.0	2 600	3 400
7416-D	80	200	96	3.1496	7.874	3.7795	312.0	340.0	2 500	3 300
7417-D	85	210	104	3.3465	8.2677	4.0945	332.0	375.0	2 300	3 000
7418-D	90	225	108	3.5433	8.8583	4.252	371.0	440.0	2 200	2 800
7419-D	95	250	110	3.7402	9.8425	4.3307	410.0	510.0	2 000	2 600
7420-D	100	265	120	9.9370	10.4331	4.7244	449.0	585.0	1 900	2 600
7421-D	105	290	130	4.1339	11.4173	5.1181	540.0	670.0	1 800	2 400
7422-D	110	320	140	4.3307	12.5984	5.5118	605.0	800.0	1 700	2 300

1) For thrust rating multiply C by 1.32 and C₀ by 2.94 (single) and C by 0.81 and C₀ by 1.47 (duplex)

2) Listed values are for machined bronze cage, ABEC-1.

For phenolic composition cage, multiply by 1.33 for both grease and oil. For phenolic composition cage, ABEC-5 or 7, multiply by 1.86 for both grease and oil. For pressed steel cage, ABEC-1, multiply by 0.67 for grease and 0.80 for oil. The speed rating adjustment factors have been determined through historical application and practice.

3) Rating for one million revolutions or 500 hours at 33 1/3 RPM.

Double row angular contact ball bearings

d 10 - 65 mm
d 0.397 - 2.582 in

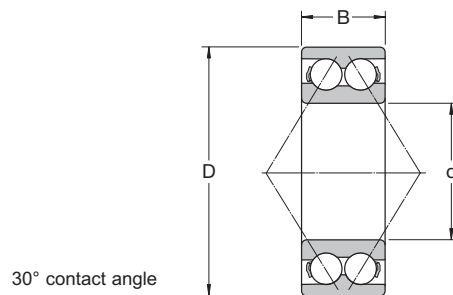

Principal dimensions						Basic load ratings		Fatigue load limit P_u	Speed ratings		Mass kg	Designations	
d	D	B	d	D	B	dynamic C	static C_0		Reference speed	Limiting speed		Bearing with metal cage	polyamide cage
mm			in			kN		kN	r/min		kg	–	
10	30	14	0.3937	1.1811	0.5512	7.61	4.3	0.183	22 000	24 000	0.051	–	3200 ATN9
12	32	15.9	0.4724	1.2598	0.6260	10.1	5.6	0.24	20 000	22 000	0.058	–	3201 ATN9
15	35	15.9	0.5906	1.3780	0.6260	11.2	6.8	0.285	17 000	18 000	0.066	–	3202 ATN9
	42	19		1.6535	0.7480	15.1	9.3	0.4	15 000	16 000	0.13	–	3302 ATN9
17	40	17.5	0.6693	1.5748	0.6890	14.3	8.8	0.365	15 000	16 000	0.096	–	3203 ATN9
	47	22.2		1.8504	0.8740	21.6	12.7	0.54	14 000	14 000	0.18	–	3303 ATN9
20	47	20.6	0.7874	1.8504	0.8110	20	12	0.51	14 000	14 000	0.16	* 3204 A	* 3204 ATN9
	52	22.2		2.0472	0.8740	23.6	14.6	0.62	13 000	13 000	0.22	* 3304 A	* 3304 ATN9
25	52	20.6	0.9843	2.0472	0.8110	21.6	14.3	0.6	12 000	12 000	0.18	* 3205 A	* 3205 ATN9
	62	25.4		2.4409	1.0000	32	20.4	0.865	11 000	11 000	0.35	* 3305 A	* 3305 ATN9
30	62	23.8	1.1811	2.4409	0.9370	30	20.4	0.865	10 000	10 000	0.29	* 3206 A	* 3206 ATN9
	72	30.2		2.8346	1.1890	41.5	27.5	1.16	9 000	9 000	0.53	* 3306 A	* 3306 ATN9
35	72	27	1.3780	2.8346	1.0630	40	28	1.18	9 000	9 000	0.44	* 3207 A	* 3207 ATN9
	80	34.9		3.1496	1.3740	52	35.5	1.5	8 500	8 500	0.71	* 3307 A	* 3307 ATN9
	80	34.9		3.1496	1.3740	52.7	41.5	1.76	7 500	8 000	0.79	3307 DJ1	–
40	80	30.2	1.5748	3.1496	1.1890	47.5	34	1.43	8 000	8 000	0.58	* 3208 A	* 3208 ATN9
	90	36.5		3.5433	1.4370	64	44	1.86	7 500	7 500	1.05	* 3308 A	* 3308 ATN9
	90	36.5		3.5433	1.4370	49.4	41.5	1.76	6 700	7 000	1.2	3308 DNRCBM	–
	90	36.5		3.5433	1.4370	68.9	64	2.45	6 700	7 000	1.05	3308 DMA	3308 DTN9
45	85	30.2	1.7717	3.3465	1.1890	51	39	1.63	7 500	7 500	0.63	* 3209 A	* 3209 ATN9
	100	39.7		3.9370	1.5630	75	53	2.24	6 700	6 700	1.4	* 3309 A	* 3309 ATN9
	100	39.7		3.9370	1.5630	61.8	52	2.2	6 000	6 300	1.5	3309 DNRCBM	–
	100	39.7		3.9370	1.5630	79.3	69.5	3	6 000	6 300	1.6	3309 DMA	–
50	90	30.2	1.9685	3.5433	1.1890	51	39	1.66	7 000	7 000	0.66	* 3210 A	* 3210 ATN9
	110	44.4		4.3307	1.7480	90	64	2.75	6 000	6 000	1.95	* 3310 A	* 3310 ATN9
	110	44.4		4.3307	1.7480	81.9	69.5	3	5 300	5 600	1.95	3310 DNRCBM	–
	110	44.4		4.3307	1.7480	93.6	85	3.6	5 300	5 600	2.15	3310 DMA	–
55	100	33.3	2.1654	3.9370	1.3110	60	47.5	2	6 300	6 300	1.05	* 3211 A	* 3211 ATN9
	120	49.2		4.7244	1.9370	112	81.5	3.45	5 300	5 300	2.55	* 3311 A	–
	120	49.2		4.7244	1.9370	95.6	83	3.55	4 800	5 000	2.55	3311 DNRCBM	–
	120	49.2		4.7244	1.9370	111	100	4.3	4 800	5 000	2.8	3311 DMA	–
60	110	36.5	2.3622	4.3307	1.4370	73.5	58.5	2.5	5 600	5 600	1.4	* 3212 A	* 3212 ATN9
	130	54		5.1181	2.1260	127	95	4.05	5 000	5 000	3.25	* 3312 A	–
65	120	38.1	2.5591	4.7244	1.5000	80.6	73.5	3.1	4 500	4 800	1.75	3213 A	–
	140	58.7		5.5118	2.3110	146	110	4.55	4 500	4 500	4.1	* 3313 A	–
	140	58.7		5.5118	2.3110	138	122	5.1	4 300	4 500	4	3313 DNRCBM	–

* SKF Explorer bearing

Double row angular contact ball bearings

d 70 - 110 mm

d 2.781 - 4.370 in

d 40 - 80 mm

d 1.575 - 3.150 in

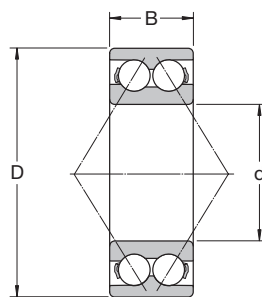

30° contact angle

Principal dimensions						Basic load ratings		Fatigue load limit P_u	Speed ratings		Mass	Designations	
d	D	B	d	D	B	dynamic	static		Reference speed	Limiting speed		Bearing with metal cage	polyamide cage
			in			kN		kN	r/min		kg	-	
70	125	39.7	2.7559	4.9213	1.5630	88.4	80	3.4	4 300	4 500	1.9	3214 A	-
	150	63.5		5.9055	2.5000	153	125	5	4 000	4 000	5.05	3314 A	-
75	130	41.3	2.9528	5.1181	1.6260	95.6	88	3.75	4 300	4 500	2.1	3215 A	-
	160	68.3		6.2992	2.6890	176	140	5.5	4 000	4 000	5.55	* 3315 A	-
80	140	44.4	3.1496	5.5118	1.7480	106	95	3.9	4 000	4 300	2.65	3216 A	-
	170	68.3		6.6929	2.6890	182	156	6	3 400	3 600	6.8	3316 A	-
	170	68.3		6.6929	2.6890	190	196	7.35	3 400	3 600	7.55	3316 DMA	-
85	150	49.2	3.3465	5.9055	1.9370	124	110	4.4	3 600	3 800	3.4	3217 A	-
	180	73		7.0866	2.8740	195	176	6.55	3 200	3 400	8.3	3317 A	-
90	160	52.4	3.5433	6.2992	2.0630	130	120	4.55	3 400	3 600	4.15	3218 A	-
	190	73		7.4803	2.8740	195	180	6.4	3 000	3 200	9.25	3318 A	-
	190	73		7.4803	2.8740	225	250	8.8	3 000	3 200	10	3318 DMA	-
95	170	55.6	3.7402	6.6929	2.1890	159	146	5.4	3 200	3 400	5	3219 A	-
	200	77.8		7.8740	3.0630	225	216	7.5	2 800	3 000	11	3319 A	-
	200	77.8		7.8740	3.0630	242	275	9.5	2 800	3 000	12	3319 DMA	-
100	180	60.3	3.9370	7.0866	2.3740	178	166	6	3 000	3 200	6.1	3220 A	-
	215	82.6		8.4646	3.2520	255	255	8.65	2 600	2 800	13.5	3320 A	-
110	200	69.8	4.3307	7.8740	2.7480	212	212	7.2	2 800	2 800	8.8	3222 A	-
	240	92.1		9.4488	3.6260	291	305	9.8	2 400	2 600	19	3322 A	-

Designation	Principal Dimensions						Basic Load Ratings				Speed Rating			Mass	
	d		D		B		dynamic		static		Lubrication			-	
	mm	in	mm	in	mm	in	N	lbf	N	lbf	Seal	Grease	Oil	kg	lb
5408 A	40	1.5748	110	4.3307	49.2	1-15/16	88 400	19 900	57 000	12 800	-	4 300	5 600	2.30	5.05
5409 A	45	1.7717	120	4.7244	54.0	2-1/8	112 000	25 200	78 000	17 600	-	4 000	5 300	3.00	6.60
5410 A	50	1.9685	130	5.1181	58.7	2-5/16	143 000	32 200	102 000	23 000	-	3 600	4 800	3.70	8.15
5411 A	55	2.1654	140	5.5118	63.5	2-1/2	146 000	32 900	102 000	23 000	-	3 200	4 300	4.70	10.50
5412 A	60	2.3622	150	5.9055	66.7	2-5/8	159 000	35 800	114 000	25 700	-	3 000	4 000	5.70	12.50
5413 A	65	2.5591	160	6.2992	71.4	2-13/16	195 000	43 900	156 000	35 100	-	2 800	3 800	6.75	15.00
5414 A	70	2.7559	180	7.0866	79.4	3-1/8	199 000	44 800	156 000	35 100	-	2 400	3 400	9.90	22.00
5415 A	75	2.9528	190	7.4803	82.55	3-1/4	225 000	50 600	190 000	42 800	-	2 200	3 200	11.16	24.60
5416 A	80	3.1496	200	7.8740	87.31	3-7/16	238 000	53 600	208 000	46 800	-	2 000	3 000	13.00	28.80

* SKF Explorer bearing

Sealed double row angular contact ball bearings

d 10 - 75 mm
d 0.394 - 2.953 in

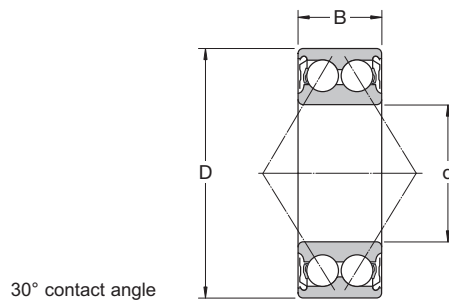

Principal dimensions						Basic load ratings		Fatigue load limit P_u	Limiting speeds		Mass	Designations	
d	D	B	d	D	B	dynamic C	static C_0		Bearing with shields	seals		Bearing with shields	seals
			in				kN		kN	r/min	kg	—	
10	30	14	0.394	1.181	0.551	7.61	4.3	0.183	24 000	17 000	0.051	3200 A-2Z	3200 A-2RS1
12	32	15.9	0.472	1.260	0.626	10.1	5.6	0.24	22 000	15 000	0.058	3201 A-2Z	3201 A-2RS1
15	35	15.9	0.591	1.378	0.626	11.2	6.8	0.285	18 000	14 000	0.066	3202 A-2Z	3202 A-2RS1
	42	19		1.654	0.748	15.1	9.3	0.4	16 000	12 000	0.13	3302 A-2Z	3302 A-2RS1
17	40	17.5	0.669	1.575	0.689	14.3	8.8	0.365	16 000	12 000	0.1	3203 A-2Z	3203 A-2RS1
	47	22.2		1.850	0.874	21.6	12.7	0.54	14 000	11 000	0.18	3303 A-2Z	3303 A-2RS1
20	47	20.6	0.787	1.850	0.811	20	12	0.51	14 000	10 000	0.16	* 3204 A-2Z	* 3204 A-2RS1
	52	22.2		2.047	0.874	23.6	14.6	0.62	13 000	9 000	0.22	* 3304 A-2Z	* 3304 A-2RS1
25	52	20.6	0.984	2.047	0.811	21.6	14.3	0.6	12 000	8 500	0.18	* 3205 A-2Z	* 3205 A-2RS1
	62	25.4		2.441	1.000	32	20.4	0.865	11 000	7 500	0.35	* 3305 A-2Z	* 3305 A-2RS1
30	62	23.8	1.181	2.441	0.937	30	20.4	0.865	10 000	7 500	0.29	* 3206 A-2Z	* 3206 A-2RS1
	72	30.2		2.835	1.189	41.5	27.5	1.16	9 000	6 300	0.52	* 3306 A-2Z	* 3306 A-2RS1
35	72	27	1.378	2.835	1.063	40	28	1.18	9 000	6 300	0.44	* 3207 A-2Z	* 3207 A-2RS1
	80	34.9		3.150	1.374	52	35.5	1.5	8 500	6 000	0.73	* 3307 A-2Z	* 3307 A-2RS1
40	80	30.2	1.575	3.150	1.189	47.5	34	1.43	8 000	5 600	0.57	* 3208 A-2Z	* 3208 A-2RS1
	90	36.5		3.543	1.437	64	44	1.86	7 500	5 000	0.93	* 3308 A-2Z	* 3308 A-2RS1
45	85	30.2	1.772	3.346	1.189	51	39	1.63	7 500	5 300	0.63	* 3209 A-2Z	* 3209 A-2RS1
	100	39.7		3.937	1.563	75	53	2.24	6 700	4 800	1.25	* 3309 A-2Z	* 3309 A-2RS1
50	90	30.2	1.969	3.543	1.189	51	39	1.66	7 000	4 800	0.65	* 3210 A-2Z	* 3210 A-2RS1
	110	44.4		4.331	1.748	90	64	2.75	6 000	4 300	1.7	* 3310 A-2Z	* 3310 A-2RS1
55	100	33.3	2.165	3.937	1.311	60	47.5	2	6 300	4 500	0.91	* 3211 A-2Z	* 3211 A-2RS1
	120	49.2		4.724	1.937	112	81.5	3.45	5 300	3 800	2.65	* 3311 A-2Z	* 3311 A-2RS1
60	110	36.5	2.362	4.331	1.437	73.5	58.5	2.5	5 600	4 000	1.2	* 3212 A-2Z	* 3212 A-2RS1
	130	54		5.118	2.126	127	95	4.05	5 000	—	2.8	* 3312 A-2Z	—
65	120	38.1	2.559	4.724	1.500	80.6	73.5	3.1	4 800	3 600	1.75	3213 A-2Z	3213 A-2RS1
	140	58.7		5.512	2.311	146	110	4.55	4 500	—	4.1	* 3313 A-2Z	—
70	125	39.7	2.756	4.921	1.563	88.4	80	3.4	4 500	—	1.9	3214 A-2Z	—
	150	63.5		5.906	2.500	153	125	5	4 000	—	5.05	3314 A-2Z	—
75	130	41.3	2.953	5.118	1.626	95.6	88	3.75	4 500	—	2.1	3215 A-2Z	—
	160	68.3		6.299	2.689	176	140	5.5	4 000	—	5.6	* 3315 A-2Z	—

* SKF Explorer bearing

Double row angular contact ball bearings

Double Row, 30° Contact Angle

Max Type

Open, Sealed, Shielded, Snap Ring

Series: 5205 E — 5218 E

Size: 25 mm — 90 mm

0.9843 in — 3.5433 in

Series: 5305 E — 5316 E

Size: 25 mm — 80 mm

0.9843 in — 3.1496 in

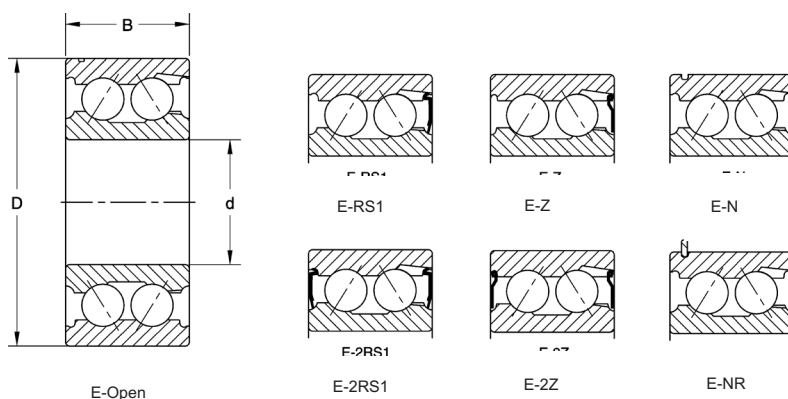

Designation	Principal Dimensions						Basic Load Ratings				Speed Rating			Mass	
	d		D		B		Dynamic C		Static C ₀		Lubrication			kg	lb
	mm	in	mm	in	mm	in	N	lbf	N	lbf	r/min	r/min	r/min		
5205 E	25	0.9843	52	2.0472	20.6	13/16	22 900	5 150	21 200	4 770	8 000	8 000	11 000	0.25	0.55
5206 E	30	1.1811	62	2.4409	23.8	15/16	30 300	6 820	28 000	6 290	7 000	7 000	9 500	0.35	0.77
5207 E	35	1.3780	72	2.8346	27.0	1-1/16	39 100	8 800	36 500	8 210	6 000	6 000	8 000	0.54	1.20
5208 E	40	1.5748	80	3.1496	30.2	1-3/16	49 500	11 100	49 000	11 000	5 600	5 600	7 500	0.73	1.60
5209 E	45	1.7717	85	3.3465	30.2	1-3/16	51 200	11 500	54 000	12 100	5 000	5 000	6 700	0.77	1.70
5210 E	50	1.9685	90	3.5433	30.2	1-3/16	53 900	12 100	58 500	13 200	4 800	4 800	6 300	0.82	1.80
5211 E	55	2.1654	100	3.9370	33.3	1-5/16	66 000	14 900	76 500	17 200	4 300	4 300	5 600	1.15	2.55
5212 E	60	2.3622	110	4.3307	36.5	1-7/16	78 100	17 600	88 000	19 800	3 800	3 800	5 000	1.50	3.30
5213 E	65	2.5591	120	4.7244	38.1	1-1/2	88 000	19 800	106 000	23 800	3 600	3 600	4 800	1.95	4.30
5214 E	70	2.7559	125	4.9213	39.7	1-9/16	101 000	22 700	125 000	28 100	3 200	3 200	4 300	2.15	4.75
5215 E	75	2.9528	130	5.1181	41.3	1-5/8	108 000	24 300	137 000	30 800	3 200	3 200	4 300	2.50	5.50
5216 E	80	3.1496	140	5.5118	44.4	1-3/4	128 000	28 800	160 000	36 000	—	2 800	3 800	3.00	6.60
5217 E	85	3.3465	150	5.9055	49.2	1-15/16	142 000	32 000	176 000	39 600	—	2 600	3 600	3.70	8.15
5218 E	90	3.5433	160	6.2992	52.4	2-1/16	151 000	34 000	193 000	43 400	—	2 400	3 400	4.55	10.00
5305 E	25	0.9843	62	2.4409	25.4	1	34 100	7 670	30 500	6 860	7 500	7 500	10 000	0.39	0.86
5306 E	30	1.1811	72	2.8346	30.2	1-3/16	46 800	10 500	43 000	9 670	6 300	6 300	8 500	0.59	1.30
5307 E	35	1.3780	80	3.1496	34.9	1-3/8	52 300	11 800	48 000	10 800	5 600	5 600	7 500	0.86	1.90
5308 E	40	1.5748	90	3.5433	36.5	1-7/16	67 100	15 100	65 500	14 700	5 000	5 000	6 700	1.15	2.55
5309 E	45	1.7717	100	3.9370	39.7	1-9/16	80 900	18 200	80 000	18 000	4 500	4 500	7 000	1.50	3.30
5310 E	50	1.9685	110	4.3307	44.4	1-3/4	95 200	21 400	95 000	21 400	4 000	4 000	5 300	2.00	4.40
5311 E	55	2.1654	120	4.7244	49.2	1-15/16	119 000	26 800	122 000	27 400	3 800	3 800	5 000	2.65	5.85
5312 E	60	2.3622	130	5.1181	54.0	2-1/8	134 000	30 200	143 000	32 100	3 400	3 400	4 500	3.30	7.30
5313 E	65	2.5591	140	5.5118	58.7	2-5/16	154 000	34 700	163 000	36 600	3 200	3 200	4 300	4.20	9.25
5314 E	70	2.7559	150	5.9055	63.5	2-1/2	172 000	38 700	186 000	41 800	2 800	2 800	3 800	5.00	11.00
5315 E	75	2.9528	160	6.2992	68.3	2-11/16	187 000	42 100	208 000	46 800	—	2 600	3 600	6.35	14.00
5316 E	80	3.1496	170	6.6929	68.3	2-11/16	201 000	45 200	236 000	53 100	—	2 400	3 400	7.25	16.00

Four-point contact ball bearings

d 15 - 90 mm
d 0.591 - 3.543 in

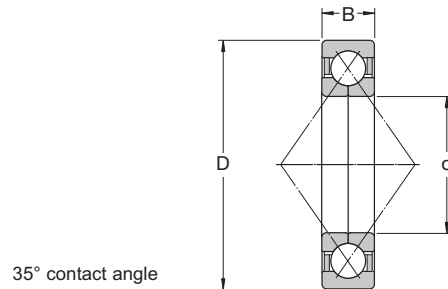

Principal dimensions						Basic load ratings		Fatigue load limit P_u	Speed ratings		Mass	Designations	
d	D	B	d	D	B	dynamic	static		Reference speed	Limiting speed		Bearing with locating slots	without loc. slots
			in				kN		kN	r/min	kg	-	
15	35	11	0.591	1.378	0.433	12.7	8.3	0.36	22 000	36 000	0.062	QJ 202 N2MA	-
17	40	12	0.669	1.575	0.472	15.9	10.6	0.45	19 000	30 000	0.082	QJ 203 N2MA	QJ 203 MA
	47	14		1.850	0.551	23.4	15	0.64	17 000	28 000	0.14	QJ 303 N2MA	-
20	52	15	0.787	2.047	0.591	29.6	20	0.85	15 000	24 000	0.18	QJ 304 N2MA	QJ 304 MA
25	52	15	0.984	2.047	0.591	25.1	20	0.83	14 000	22 000	0.16	QJ 205 N2MA	QJ 205 MA
	62	17		2.441	0.669	39	28	1.18	12 000	20 000	0.29	QJ 305 N2MA	QJ 305 MA
30	62	16	1.181	2.441	0.630	35.1	28.5	1.2	12 000	19 000	0.24	QJ 206 N2MA	QJ 206 MA
	72	19		2.835	0.748	49.4	38	1.63	10 000	17 000	0.42	QJ 306 N2MA	QJ 306 MA
35	72	17	1.378	2.835	0.669	46.2	39	1.63	10 000	17 000	0.36	QJ 207 N2MA	QJ 207 MA
	80	21		3.150	0.827	59.2	46.5	1.96	9 500	15 000	0.57	QJ 307 N2MA	QJ 307 MA
40	80	18	1.575	3.150	0.709	52.7	45	1.9	9 000	15 000	0.45	QJ 208 N2MA	QJ 208 MA
	90	23		3.543	0.906	71.5	58.5	2.45	8 500	14 000	0.78	QJ 308 N2MA	QJ 308 MA
45	85	19	1.772	3.346	0.748	58.5	51	2.16	8 500	14 000	0.52	-	QJ 209 MA
	100	25		3.937	0.984	93.6	76.5	3.25	7 500	12 000	1.05	QJ 309 N2MA	QJ 309 MA
50	90	20	1.969	3.543	0.787	61.8	56	2.4	7 500	13 000	0.59	QJ 210 N2MA	QJ 210 MA
	110	27		4.331	1.063	111	91.5	3.9	6 700	11 000	1.35	-	QJ 310 MA
55	100	21	2.165	3.937	0.827	79.3	76.5	3.2	7 000	11 000	0.77	QJ 211 N2MA	QJ 211 MA
	120	29		4.724	1.142	127	108	4.55	6 000	10 000	1.75	QJ 311 N2MA	QJ 311 MA
60	110	22	2.362	4.331	0.866	92.3	86.5	3.65	6 300	10 000	0.99	QJ 212 N2MA	QJ 212 MA
	130	31		5.118	1.220	146	125	5.3	5 600	9 000	2.15	QJ 312 N2MA	QJ 312 MA
65	120	23	2.559	4.724	0.906	104	104	4.4	5 600	9 500	1.2	QJ 213 N2MA	QJ 213 MA
	140	33		5.512	1.299	165	146	6.1	5 300	8 500	2.7	-	QJ 313 MA
70	125	24	2.756	4.921	0.945	114	114	4.8	5 600	9 000	1.32	QJ 214 N2MA	QJ 214 MA
	150	35		5.906	1.378	186	166	6.7	4 800	8 000	3.15	QJ 314 N2MA	QJ 314 MA
75	130	25	2.953	5.118	0.984	117	122	5.2	5 300	8 500	1.45	QJ 215 N2MA	QJ 215 MA
	160	37		6.299	1.457	199	186	7.35	4 500	7 500	3.9	QJ 315 N2MA	-
80	140	26	3.150	5.512	1.024	138	146	5.85	4 800	8 000	1.85	QJ 216 N2MA	QJ 216 MA
	170	39		6.693	1.535	216	208	8	4 300	7 000	4.6	QJ 316 N2MA	-
85	150	28	3.346	5.906	1.102	148	160	6.2	4 500	7 500	2.25	QJ 217 N2MA	QJ 217 MA
	180	41		7.087	1.614	234	236	8.65	4 000	6 700	5.45	QJ 317 N2MA	-
90	160	30	3.543	6.299	1.181	174	186	6.95	4 300	7 000	2.75	QJ 218 N2MA	-
	190	43		7.480	1.693	265	285	10.2	3 800	6 300	6.45	QJ 318 N2MA	-

Four-point contact ball bearings

d 95 - 200 mm

d 3.740 - 7.874 in

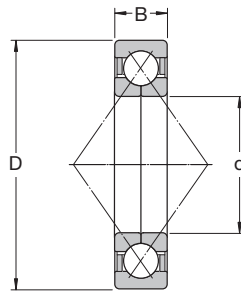

35° contact angle

Principal dimensions						Basic load ratings		Fatigue load limit P_u	Speed ratings		Mass kg	Designations	
d	D	B	d	D	B	dynamic C	static C_0		Reference speed	Limiting speed		Bearing with locating slots	without loc. slots
mm			in			kN		kN	r/min		kg	-	
95	170	32	3.740	6.693	1.260	199	212	7.8	4 000	6 700	3.35	QJ 219 N2MA	-
	200	45		7.874	1.772	286	315	11	3 600	6 000	7.45	QJ 319 N2MA	-
100	180	34	3.937	7.087	1.339	225	240	8.65	3 800	6 300	4.05	QJ 220 N2MA	-
	215	47		8.465	1.850	307	340	11.6	3 400	5 600	9.3	QJ 320 N2MA	-
110	200	38	4.331	7.874	1.496	265	305	10.4	3 400	5 600	5.6	QJ 222 N2MA	-
	240	50		9.449	1.969	390	475	15	3 000	4 800	12.5	QJ 322 N2MA	-
120	215	40	4.724	8.465	1.575	286	340	11.2	3 200	5 000	6.95	QJ 224 N2MA	-
	260	55		10.236	2.165	390	490	15	2 800	4 500	16	QJ 324 N2MA	-
130	230	40	5.118	9.055	1.575	296	365	11.6	2 800	4 800	7.75	QJ 226 N2MA	-
	280	58		11.024	2.283	423	560	16.6	2 600	4 000	19.5	QJ 326 N2MA	-
140	250	42	5.512	9.843	1.654	325	440	13.2	2 600	4 300	9.85	QJ 228 N2MA	-
	300	62		11.811	2.441	468	640	18.6	2 400	3 800	24	QJ 328 N2MA	-
150	270	45	5.906	10.630	1.772	377	530	15.3	2 400	4 000	12.5	QJ 230 N2MA	-
	320	65		12.598	2.559	494	710	19.6	2 200	3 600	29	QJ 330 N2MA	-
160	290	48	6.299	11.417	1.890	423	620	17.6	2 200	3 800	15.5	QJ 232 N2MA	-
	340	68		13.386	2.677	540	815	21.6	2 000	3 400	34.5	QJ 332 N2MA	-
170	310	52	6.693	12.205	2.047	436	670	18.3	2 200	3 400	19.5	QJ 234 N2MA	-
	360	72		14.173	2.835	618	965	25	1 900	3 200	41.5	QJ 334 N2MA	-
180	320	52	7.087	12.598	2.047	449	710	19	2 000	3 400	20.5	QJ 236 N2MA	-
	380	75		14.961	2.953	637	1 020	26	1 800	3 000	47.5	QJ 336 N2MA	-
190	400	78	7.480	15.748	3.071	702	1 160	28.5	1 700	2 800	49	QJ 338 N2MA	-
200	360	58	7.874	14.173	2.283	540	915	23.2	1 800	3 000	28.5	QJ 240 N2MA	-

Double row cam rollers

d 32 - 80 mm
d 1.260 - 3.150 in

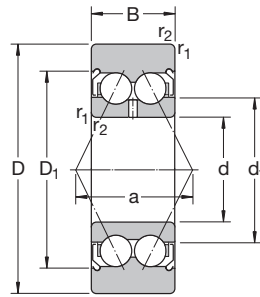

Dimensions													Limiting speed	Mass	Designations	
D	B	d	D	B	d	\tilde{d}_1	\tilde{D}_1	$r_{1,2}$ Min	a	C	C_0	P_u			Cam roller with crowned runner surface	cylindrical runner surface
mm			in							kN		kN	r/min	kg	—	
32	14	10	1.260	0.551	0.394	17.7	25	0.6	15	7.15	3.8	0.16	16 000	0.062	305800 C-2Z	—
35	15.9	12	1.378	0.626	0.472	19.1	27.7	0.6	16.5	9.56	4.9	0.208	14 000	0.078	305801 C-2Z	305701 C-2Z
40	15.9	15	1.575	0.626	0.591	22.1	30.7	0.6	18	10.6	5.85	0.25	12 000	0.1	305802 C-2Z	305702 C-2Z
47	17.5	17	1.850	0.689	0.669	25.2	35	0.6	20	13.5	7.8	0.325	11 000	0.16	305803 C-2Z	305703 C-2Z
52	20.6	20	2.047	0.811	0.787	29.4	40.9	1	24	17.2	10	0.425	9 500	0.22	305804 C-2Z	305704 C-2Z
62	20.6	25	2.441	0.811	0.984	34.4	45.9	1	26.5	19.5	12.5	0.53	8 000	0.32	305805 C-2Z	305705 C-2Z
72	23.8	30	2.835	0.937	1.181	41.4	55.2	1	31	27.6	18.6	0.8	6 700	0.49	305806 C-2Z	305706 C-2Z
80	27	35	3.150	1.063	1.378	48.1	63.9	1.1	36.5	33.2	21.2	0.9	5 600	0.65	305807 C-2Z	305707 C-2Z

